

SILMAX

QUALITY AS A STANDARD

FORATURA
DRILLING
BOHREN
PERÇAGE



SILMAX.IT

CATALOGHI SILMAX

SILMAX CATALOGUES / SILMAX-KATALOGE / CATALOGUES SILMAX



Catalogo generale
General Catalog



Alto Rendimento
High Performance



Titanio Superleghe, Acciaio Inox
Titanium Super Alloys, Stainless Steel



Matrici per l'estrusione dell'alluminio
Dies for aluminum extrusion



Stampi
Molds



Foratura
Drilling



Punte a cannone
Gun drills



Maschi
Taps



Aerospace
Aerospace

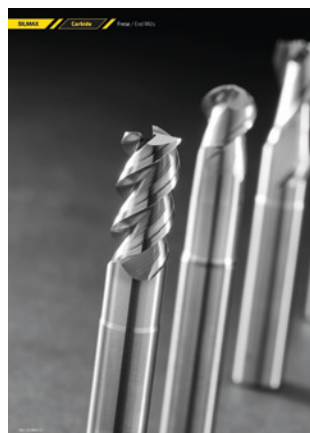

Leghe leggere
Light Alloys



Materiali compositi
Composite Materials



Silsaving
Silsaving

LA NOSTRA STORIA

OUR HISTORY / UNSERE GESCHICHTE / NOTRE HISTOIRE

1819



Paul Alessio inizia a forgiare i suoi primi utensili. La piccola officina si chiama "L'Usine".

Paul Alessio begins to forge his first tools. The small workshop is called "L'Usine".

Paul Alessio beginnt seine ersten Werkzeuge zu schmieden. Die kleine Werkstatt heißt "L'Usine".

Paul Alessio commence à forger ses premiers outils. Le petit atelier s'appelle « L'Usine ».

1955



Sotto la guida di Enrico M. Fumagalli "L'Usine" riprende l'attività produttiva.

Under the control of Enrico M. Fumagalli, the "Usine" resumed its tool production.

Unter der Leitung von Enrico M. Fumagalli nimmt die "Usine" die Produktionstätigkeit wieder auf.

Sous la direction de Monsieur Enrico M. Fumagalli, « L'Usine » reprend son activité de production.

1975



"L'Usine" diventa **Silmax, una moderna SPA.**

"L'Usine" becomes **the modern Silmax, SPA.**

Aus "L'Usine" wird **Silmax modernes SPA.**

« L'Usine » devient **Silmax, une SPA moderne.**

1984



Joint-venture Silmax Spa **Balzers AG.**

Joint-venture Silmax Spa **Balzers AG.**

Joint-venture Silmax Spa **Balzers AG.**

Joint-venture Silmax Spa **Balzers AG.**

2005



Silmax celebra i suoi **50 anni.**

Silmax celebrates its **50th birthday.**

Silmax feiert seine **50 Jahre.**

Silmax fête son **50e anniversaire.**

2012



Vengono inaugurate le sedi commerciali in **India, Cina e Germania.**

New commercial branches open in **India, China and Germany.**

Verkaufsbüros in **Indien, China und Deutschland** werden eröffnet.

Des bureaux de vente sont inaugurés en **Inde, en Chine, en Allemagne.**

2013



Silmax inaugura il **nuovo centro di rivestimento.**

Silmax **new plant for PVD coating.**

Silmax eröffnet das **neue Zentrum der Beschichtung.**

Silmax inaugure un **nouveau centre de revêtement.**

2019



Silmax 200 anni!

Silmax 200 years!

Silmax 200 Jahre!

Silmax fête son 200 anniversaire!

2021



5 nuove rettifiche e 1 nuovo impianto PVD.

5 new grinding machines and 1 new PVD unit.

5 neue Schleifmaschinen 1 neues PVD-System.

5 nouvelles rectifieuses et 1 nouveau système PVD.

2022



Silmax continua la sua storia e il suo **sviluppo** sempre attenta a mantenere alta la qualità dei suoi prodotti e la soddisfazione dei suoi clienti.

Silmax continues its history and its **development**, always careful to maintain the high quality of its products and the satisfaction of its customers.

Silmax setzt seine Geschichte und **Entwicklung** mit dem Ziel fort, die hohe Qualität seiner Produkte und die Zufriedenheit seiner Kunden zu.

Aujourd'hui, Silmax poursuit son histoire et son **développement** en veillant toujours à maintenir en haute la qualité de ses produits et la satisfaction de ses clients.

2023



Nuova apertura dello stabilimento in China.

New plant opening in China.

Neue Produktionsanlagen in China.

Ouverture d'une nouvelle usine en Chine.

PRODOTTI SPECIALI

SPECIAL TOOLS / SPEZIELLE PRODUKTE / PRODUITS SPÉCIAUX

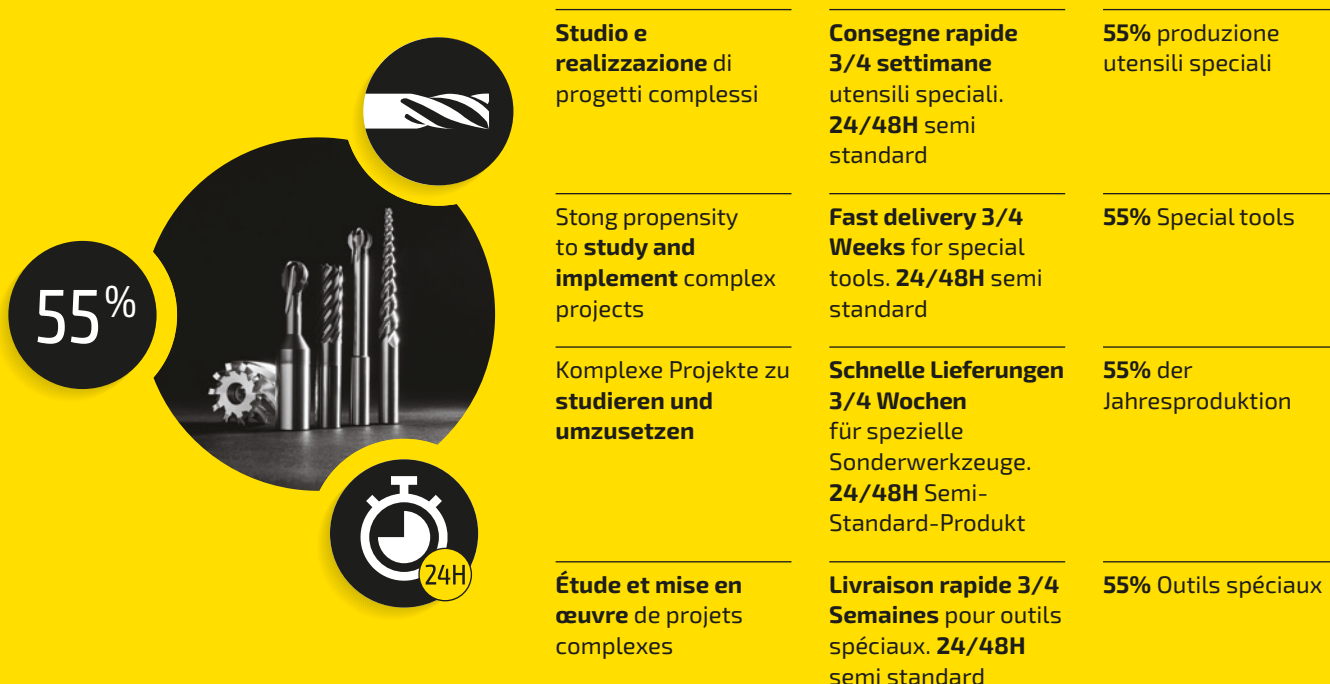

I NUMERI DI SILMAX

SILMAX FIGURES / SILMAX ZAHLEN / CHIFFRES SILMAX

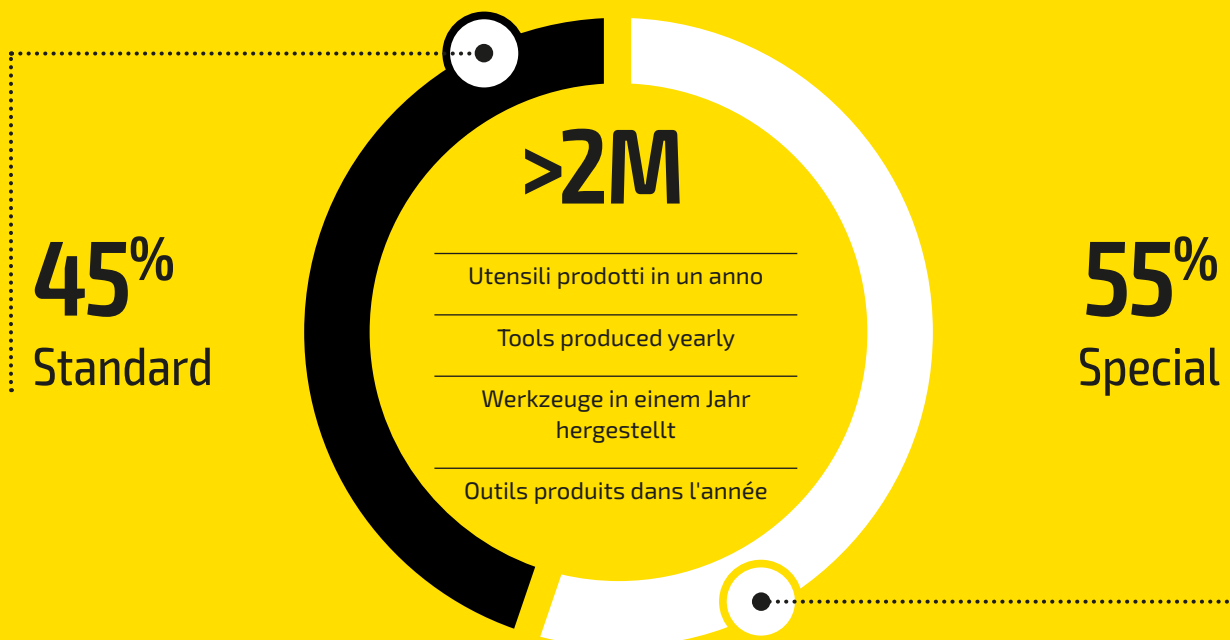

I NOSTRI MERCATI

OUR MARKETS / UNSERE MÄRKTE / LES PRINCIPAUX SECTEURS

1

Aereonautica

Aerospace
Luftfahrtbereich
Aéronautique

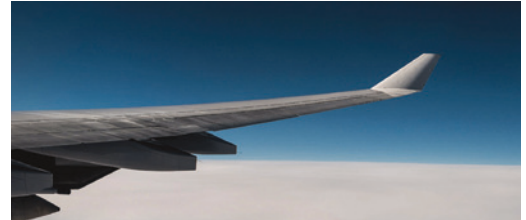

2

Stampi

Molds
Formenbau
Moules



3

Automobilistico

Automotive
Automobil
Automobile



4

Energia

Energy
Energie
Énergie



5

Meccanica generale

General Mechanics
Allgemeine Mechanik
Mécanique générale



6

Medicale

Medical
Medizinischer Bereich
Médical



NUOVA FORATURA SILMAX: PRODUTTIVITÀ E VERSATILITÀ

SILMAX presenta il **nuovo programma di foratura**, inserendo nuovi prodotti e ampliando la gamma di quelli esistenti.

Tutti i prodotti sono sviluppati con tecnologie di ultima generazione per garantire la **massima produttività ed affidabilità nelle operazioni più critiche e complesse**.

Le **nuove geometrie** sviluppate offrono una truciatura regolare e costante, grazie ai **trattamenti superficiali** che rendono il **vano gola molto scorrevole**, assicurando **bassi sforzi torsionali** e una **maggiore precisione** su una ampia gamma di materiali (**acciai, ghise, inossidabili, leghe di titanio e superleghe**).

Per quanto riguarda le **novità** vengono introdotte:

- **punte a 4 pattini di guida** per fori di precisione disponibili nelle versioni 5xD, 8xD e 12xD;
- **punte con le geometrie specifiche per leghe leggere**, con fori di lubrificazione, disponibili nelle lunghezze 5xD, 15xD, 20xD e 25xD.

L' AMPLIAMENTO della gamma è relativo a

- **punte standard** con inserimento di articoli con lunghezza 12xD;
- **punte extra-lunghe** con fori di lubrificazione e geometria completamente rivista, nelle lunghezze 15xD, 20xD, 25xD e 30xD;
- **punte fora-alesa** con fori di lubrificazione disponibili nelle lunghezze 3xD e 5xD;
- **alesatori centesimali** con inserimento di due nuove famiglie, versione extra corta e lunga.

NEW DRILLING BY SILMAX: PRODUCTIVITY AND VERSATILITY

SILMAX presents its **new drilling programme**, introducing new products and expanding its range of available items. All products are developed using state-of-the-art technologies to ensure the **utmost productivity and reliability in the most critical and complex operations**.

The **newly developed geometries** offer a regular and constant chipping, thanks to the **surface treatments**, which make the **groove space very smooth**, ensuring **low torsional stresses** and **higher precision** on a wide range of materials (**steels, cast irons, stainless steels, titanium alloys and superalloys**).

These are the **novelties** in our catalogue:

- **drills with 4 guide pads** for precision drills, available in 5xD, 8xD and 12xD versions;
- **drills with specific geometry for light alloys**, with lubrication holes, available in 5xD, 15xD, 20xD and 25xD lengths.

The EXTENSION of the range concerns

- **standard drills**, with the addition of items in 12xD length;
- **extra-long drills**, with lubrication holes and completely revised geometry in 15xD, 20xD, 25xD and 30xD lengths;
- **drill reamers**, with lubrication holes in 3xD and 5xD lengths;
- **centesimal reamers**, with the addition of two new families, in extra short and long versions.

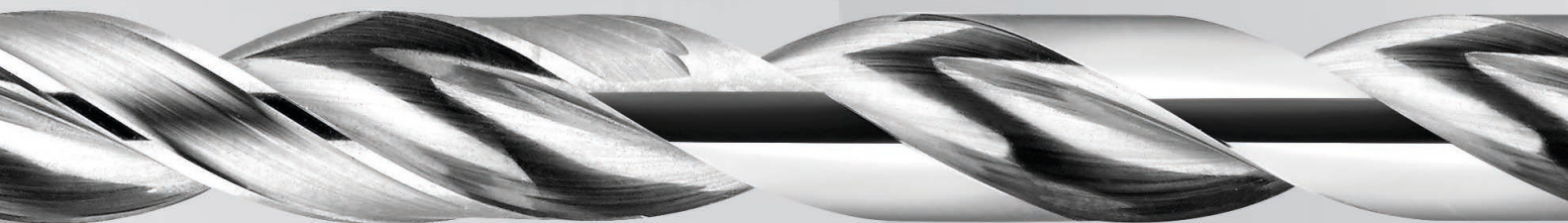

NEUES SILMAX-BOHRPROGRAMM: PRODUKTIVITÄT UND VIELSEITIGKEIT

SILMAX stellt das **neue Bohrprogramm vor**, in dem neue Produkte eingeführt werden und das bestehende Sortiment erweitert wird. Alle Produkte sind mit der neuesten Technologie entwickelt, um ein **Höchstmaß an Produktivität und Zuverlässigkeit bei den kritischsten und komplexesten Aufgaben zu gewährleisten**.

Die neu **entwickelten Geometrien** bieten eine gleichmäßige und konstante Zerspanung an. Dank der **Oberflächenbehandlungen**, die die **Spanut sehr gleitfähig** machen und **geringe Torsionsbeanspruchung** annimmt. Dadurch wird eine breite Auswahl und eine **höhere Präzision** von Materialien gewährleistet (**Stahl, Gusseisen, Rostfreier Stahl, Titanlegierungen und Superlegierungen**).

Folgende **neueheiten** werden eingeführt :

- **Bohrer mit 4 Führungsleisten** für Präzisionsbohrungen verfügbar in den Ausführungen 5xD, 8xD e 12xD;
- **Bohrer mit einsatzbezogener Geometrie für Leichtlegierungen**, mit Innenkühlkanälen in den Längen 5xD, 15xD, 20xD und 25xD verfügbar.

Die ERWEITERUNG der Produktpalette bezieht sich auf

- **Standard-Bohrer** mit der Einführung von Artikeln der Länge 12xD;
- **Extra-lange Bohrer** mit Innenkühlkanälen und komplett neu überarbeiteter Geometrie, in den Längen 15xD, 20xD, 25xD und 30xD verfügbar;
- **Bohrreibahle** mit Innenkühlkanälen in den Längen 3xD und 5xD verfügbar;
- **Das Sortiment der Hundertstel-Reibahle** wird mit der Einführung der extra-kurzen und extra-langen Varianten erweitert.

NUOUEAU PROGRAMME PERÇAGE SILMAX: PRODUCTIVITÉ ET VERSATILITÉ

SILMAX présente son **nouveau programme de perçage**, en ajoutant de nouveaux articles et en élargissant la gamme des produits existants. Tous les produits sont développés à l'aide d'une technologie de pointe, pour assurer **une productivité et une fiabilité maximales dans les opérations les plus critiques et les plus complexes**.

Les **nouvelles géométries** développées offrent une évacuation régulière et constante des copeaux, grâce à des **traitements de surface** qui rendent **l'espace de rainure très lisse**, en garantissant de **faibles contraintes de torsion** et une **plus haute précision** sur une large gamme de matériaux (**aciers, fontes, aciers inoxydables, alliages de titane et superalliages**).

Les **nouveautés** du catalogue sont les suivantes:

- **forets avec 4 patins de guidage** pour les trous de précision, disponibles en versions 5xD, 8xD et 12xD;
- **forets à géométrie spécifique pour alliages légers**, avec trous de lubrification, disponibles en longueurs 5xD, 15xD, 20xD et 25xD.

L'EXTENSION de la gamme concerne:

- **forets standards**, avec ajout d'articles en longueur 12xD;
- **forets extra-longs**, avec trous de lubrification et géométrie entièrement révisée, en longueurs 15xD, 20xD, 25xD et 30xD;
- **forets-alésoirs**, avec trous de lubrification, disponibles en longueurs 3xD et 5xD;
- **alésoirs au centième**, avec ajout de deux nouvelles familles, en versions extra courte et extra-longue.

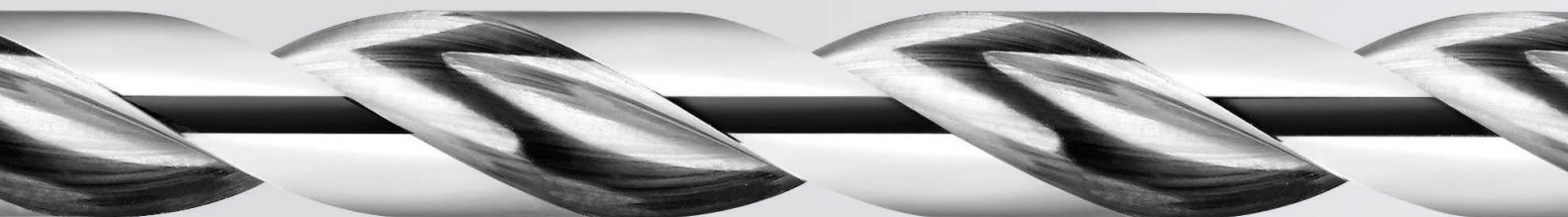

NUOVA FORATURA SILMAX: PRODUTTIVITÀ E VERSATILITÀ

RIVESTIMENTI PVD

I rivestimenti utilizzati e realizzati nel centro rivestimenti Silmax sono accuratamente selezionati per ogni tipologia di prodotto, così da assicurare una **riduzione del calore generato**, una **migliore evacuazione** del truciolo ed **un aumento della vita utensile** in ogni situazione.

In base alle condizioni di impiego sono stati selezionati la **ricopertura ed il trattamento** più idonei e performanti:

- **HMX Balinit® X-Pro + 4S**. Ricopertura base AlCrN applicata alle serie di punte per foratura di acciai fino ad una profondità di 12xD;
- **HMC Balinit® Latuma + 4S**. Ricopertura base ALTiN applicata alle serie 4 pattini, alla foratura profonda ed alla foratura inox.

Aspetto fondamentale correlato alla **ricopertura delle punte** è quello **del trattamento delle superfici**, che Silmax nell'ambito della **tecnologia 4S**, ha ottimizzato per le diverse famiglie in base alle caratteristiche dell'applicazione attesa e delle geometrie utensile dei trattamenti personalizzati, per migliorare le performance.

NEW DRILLING BY SILMAX: PRODUCTIVITY AND VERSATILITY

PVD COATING

The coatings used for our drills are made at Silmax coating centre and accurately selected for each type of product, in order to enable a **reduction of generated heat**, **better chip evacuation** and an **increased tool life** in every situation.

The most suitable and best performing coating and treatment have been selected according to the conditions of use:

- **HMX Balinit® X-Pro + 4S**. AlCrN-based coating applied to the series of drills for drilling steels up to a depth of 12xD;
- **HMC Balinit® Latuma + 4S**. ALTiN-based coating applied to 4-guide pad series, to deep drilling and drilling of stainless steel.

A crucial aspect related to **drill coating** is **surface treatment**. Within the **4S technology**, Silmax has optimised customised treatments for the different product families, according to the features of expected applications and tool geometries, in order to improve performances.



HMC

NEUES SILMAX-BOHRPROGRAMM: PRODUKTIVITÄT UND VIELSEITIGKEIT

PVD-BESCHICHTUNGEN

Die im Silmax-Beschichtungszentrum verwendeten und durchgeführten Beschichtungen werden sorgfältig für jede Produktart ausgewählt, um eine **Reduzierung der erzeugten Wärme**, eine **bessere Spanabfuhr** und eine **Erhöhung der Standzeit des Werkzeuges** in jeder Situation zu gewährleisten.

Je nach Einsatzbedingungen wurden die geeignetste und leistungsstärkste Beschichtung und Behandlung ausgewählt:

- **HMX Balinit® X-Pro + 4S.** AlCrN-basierte Beschichtung für eine Linie an Bohrern für die Bearbeitung von Stahl bis zu einer Bohrtiefe von 12xD;
- **HMC Balinit® Latuma + 4S.** AlCrN-basierte Beschichtung für eine Linie an Bohrern mit 4 Leisten, für das Tieflochbohren und das Bohren in Edelstahl.

Ein wesentlicher Aspekt **der Bohrerbeschichtung** ist die Oberflächenbehandlung. Im Rahmen der **4S-Technologie** hat Silmax für die verschiedenen Familien der Werkzeugeigenschaften entsprechend die kundenspezifischen Behandlungen optimiert, um die Leistung zu verbessern.

NOUVEAU PROGRAMME PERÇAGE SILMAX: PRODUCTIVITÉ ET VERSATILITÉ

REVÊTEMENTS PVD

Les revêtements utilisés et produits dans le centre de revêtement de Silmax sont soigneusement sélectionnés pour chaque type de produit afin de garantir une **réduction de la chaleur générée**, une **meilleure évacuation des copeaux** et une **augmentation de la durée de vie de l'outil** dans toutes les situations.

Le revêtement et le traitement les plus adaptés et les plus performants ont été sélectionnés en fonction des conditions d'utilisation:

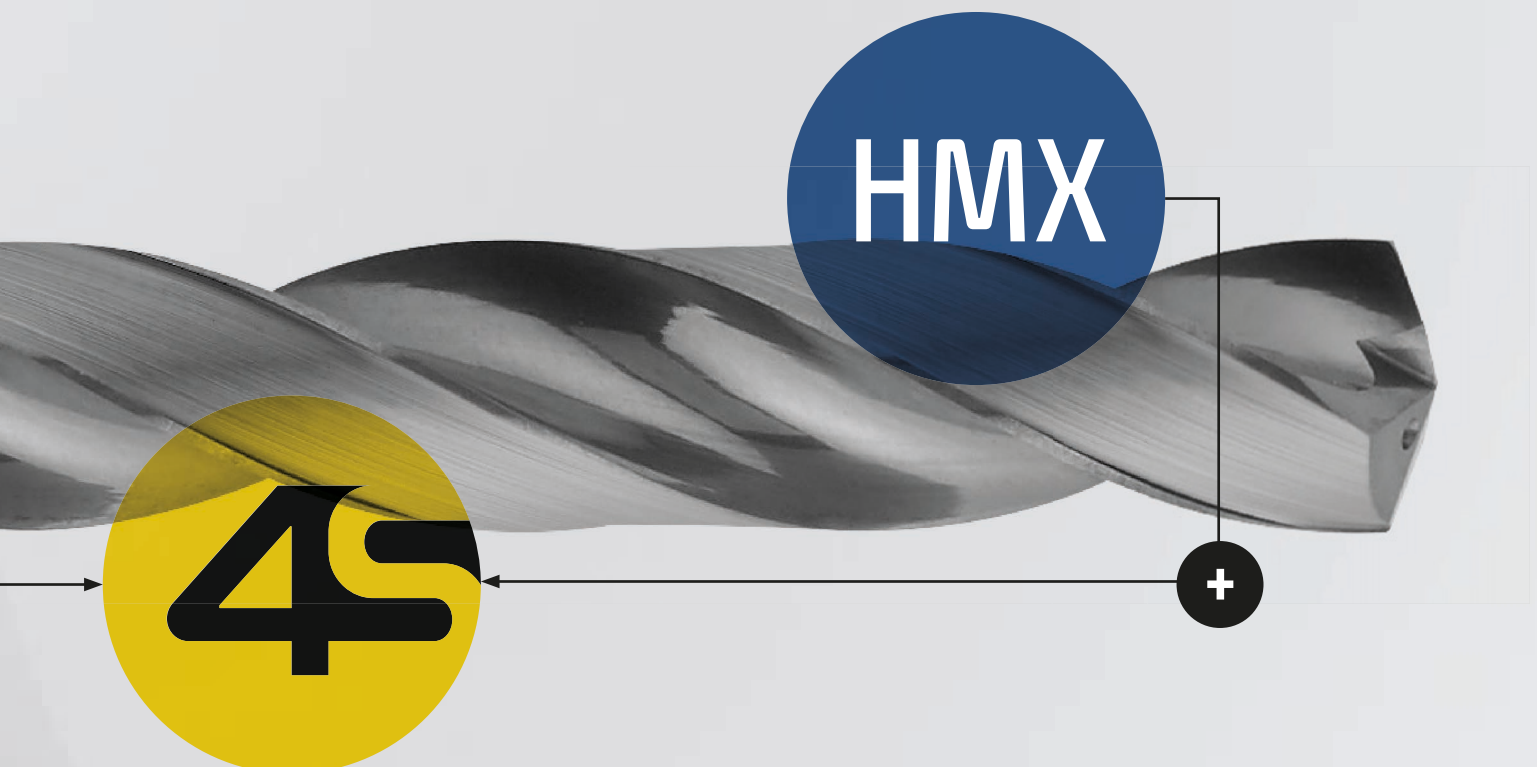

- **HMX Balinit® X-Pro + 4S.** Revêtement à base AlCrN appliqué aux séries de forets pour le perçage des aciers jusqu'à une profondeur de 12xD;
- **HMC Balinit® Latuma + 4S.** Revêtement à base AlCrN appliqué aux séries 4 patins, au perçage profond et au perçage d'acier inoxydable.

Un aspect fondamental lié au **revêtement des forets** est celui du **traitement de surfaces**. Dans le cadre de la **technologie 4S**, Silmax a optimisé des traitements personnalisés pour les différentes familles de produits en fonction de l'application prévue et des géométries de l'outil afin d'améliorer les performances.





PHM

Punte HM per acciaio fino 12xD
 HM Drills for Steel up to 12xD
 HM-Bohrer für Stahl bis 12xD
 Forets HM pour acier jusqu'à 12xD

	Codice Code	Ø (D mm)	Descrizione	Description	Beschreibung	Description
	3030A	3,0 ÷ 20,0	Punta 3xD senza fori	3xD Drill without internal coolant	3xD Bohrer ohne IK	3xD Foret sans trous de lubrification
	3031A	3,0 ÷ 20,0	Punta 3xD con fori	3xD Drill with internal coolant	3xD Bohrer mit IK	3xD Foret avec trous de lubrification
	3050A	3,0 ÷ 20,0	Punta 5xD senza fori	5xD Drill without internal coolant	5xD Bohrer ohne IK	5xD Foret sans trous de lubrification
	3051A	3,0 ÷ 20,0	Punta 5xD con fori	5xD Drill with internal coolant	5xD Bohrer mit IK	5xD Foret avec trous de lubrification
	3081A	3,0 ÷ 20,0	Punta 8xD con fori	8xD Drill with internal coolant	8xD Bohrer mit IK	8xD Foret avec trous de lubrification
	3121A	3,0 ÷ 18,0	Punta 12xD con fori	12xD Drill with internal coolant	12xD Bohrer mit IK	12xD Foret avec trous de lubrification

PH4

Punte HM per acciaio 4 pattini fino 12xD
 4 double margin HM drills for steel up to 12xD
 HM-Bohrer für Stahl mit 4 Führungsfasen bis 12xD
 Forets HM pour acier 4 patins de guidage jusqu'à 12xD

	3054A	3,0 ÷ 20,0	Punta 4 pattini 5xD con fori	5xD Drill with internal coolant	5xD Bohrer mit IK	5xD Foret avec trous de lubrification
	3084A	3,0 ÷ 20,0	Punta 4 pattini 8xD con fori	8xD Drill with internal coolant	8xD Bohrer mit IK	8xD Foret avec trous de lubrification
	3124A	3,0 ÷ 19,5	Punta 4 pattini 12xD con fori	12xD Drill with internal coolant	12xD Bohrer mit IK	12xD Foret avec trous de lubrification

Acciaio
Steel
Stahl
Acier

P

Acciaio Temprato
Hardened Steel
Gehärteter Stahl
Acier trempé

H

Ghisa
Cast Iron
Gusseisen
Fonte

K

Acciaio Inox
Stainless Steel
Edelstahl
Acier inoxydable

M

HRSA - Titanio
HRSA - Titanium
HRSA - Titan
HRSA - Titane

S

Metalli non ferrosi
Non-ferrous metals
NE-Metalle
Matériaux non ferreux

N

NON ISO
Not ISO
Keine ISO
Pas d'ISO





O

Pagina / Page
Seite / Page

	•	-	•	-	-	-	-	18
	•	-	•	-	-	-	-	22
	•	-	•	-	-	-	-	26
	•	-	•	-	-	-	-	30
	•	-	•	-	-	-	-	34
	•	-	•	-	-	-	-	38
	•	-	•	-	-	-	-	40
	•	-	•	-	-	-	-	42
	•	-	•	-	-	-	-	44



PHP

Punte HM per acciaio foratura profonda fino 30xD
 HM Deep drilling for Steel up to 30xD
 HM-Bohrer zum Tiefbohren von Stahl bis 30xD
 Forets HM pour acier, pour des profondeurs jusqu'à 30xD

	Codice Code	Ø (D mm)	Descrizione	Description	Beschreibung	Description
	3151A	3,0 ÷ 15,0	Punta 15xD con fori	15xD Drill with internal coolant	15xD Bohrer mit IK	15xD Foret avec trous de lubrification
	3201A	3,0 ÷ 16,0	Punta 20xD con fori	20xD Drill with internal coolant	20xD Bohrer mit IK	20xD Foret avec trous de lubrification
	3251A	3,0 ÷ 14,0	Punta 25xD con fori	25xD Drill with internal coolant	25xD Bohrer mit IK	25xD Foret avec trous de lubrification
	3301A	3,0 ÷ 12,0	Punta 30xD con fori	30xD Drill with internal coolant	30xD Bohrer mit IK	30xD Foret avec trous de lubrification



PHH

Punte HM fora alesia
 HM Drilling-boring
 HM Bohreibahe
 Forets HM perçage-alésage

	4031A	4,0 ÷ 16,0	Punta fora-alesia 3xD con fori	3xD Drilling-boring with internal coolant	3xD Bohreibahe mit IK	3xD Foret perçage-alésage avec trous de lubrification
	4051A	4,0 ÷ 16,0	Punta fora-alesia 5xD con fori	5xD Drilling-boring with internal coolant	5xD Bohreibahe mit IK	5xD Foret perçage-alésage avec trous de lubrification

PHF



Punte HM piate
 HM Drills Flat
 HM-Flachbohrer
 Forets HM monobloc type plat

	4038A	3,0 ÷ 20,0	Punta piate 3xD con fori	Flat drill 3xD with holes	Flachbohrer 3xD mit Kanal	Foret plat 3xD avec trous
	4058A	3,0 ÷ 20,0	Punta piate 5xD con fori	Flat drill 5xD with holes	Flachbohrer 5xD mit Kanal	Foret plat 5xD avec trous

	Acciaio Steel Stahl Acier	Acciaio Temprato Hardened Steel Gehärteter Stahl Acier trempé	Ghisa Cast Iron Gusseisen Fonte	Acciaio Inox Stainless Steel Edelstahl Acier Inoxydable	HRSA - Titanio HRSA - Titanium HRSA - Titan HRSA - Titane	Metalli non ferrosi Non-ferrous metals NE-Metalle Matières non ferreuses	NON ISO Not ISO Keine ISO Pas d'ISO	Pagina / Page Seite / Page
	P	H	K	M	S	N	O	
	•	-	•	-	-	-	-	46
	•	-	•	-	-	-	-	47
	•	-	•	-	-	-	-	48
	•	-	•	-	-	-	-	49
	•	-	•	•	-	•	-	50
	•	-	•	•	-	•	-	51
	•	-	•	•	-	-	-	52
	•	-	•	•	-	-	-	56

PHS

Punte HM per acciaio inox fino 8xD
 HM Drills for Inox up to 8xD
 HM-Bohrer für Edelstahl bis zu 8xD
 Forets HM pour acier inoxydable jusqu'à 8xD

	Codice Code	Ø (D mm)	Descrizione	Description	Beschreibung	Description
	3031S	3,0 ÷ 20,0	Punta 3xD con fori	3xD Drill with internal coolant	3xD Bohrer mit IK	3xD Foret avec trous de lubrification
	3051S	3,0 ÷ 20,0	Punta 5xD con fori	5xD Drill with internal coolant	5xD Bohrer mit IK	5xD Foret avec trous de lubrification
	3081S	3,0 ÷ 20,0	Punta 8xD con fori	8xD Drill with internal coolant	8xD Bohrer mit IK	8xD Foret avec trous de lubrification



PHN

Punte HM per Alluminio fino 25xD
 HM Drills for Alu up to 25xD
 HM-Bohrer für Alu bis 25xD
 Forets HM pour Alu jusqu'à 25xD

	3051N	3,0 ÷ 20,0	Punta 5xD con fori	5xD Drill with internal coolant	5xD Bohrer mit IK	5xD Foret avec trous de lubrification
	3151N	3,0 ÷ 12,0	Punta 15xD con fori	15xD Drill with internal coolant	15xD Bohrer mit IK	15xD Foret avec trous de lubrification
	3201N	3,0 ÷ 12,0	Punta 20xD con fori	20xD Drill with internal coolant	20xD Bohrer mit IK	20xD Foret avec trous de lubrification
	3251N	3,0 ÷ 10,0	Punta 25xD con fori	25xD Drill with internal coolant	25xD Bohrer mit IK	25xD Foret avec trous de lubrification

PHG



Punte a Gradino fino 3.5xD
 Step Drills
 Stufenbohrer
 Forets étagés

	3825	M4 ÷ M12	Punta 2.5xD con fori	2.5xD Drill with internal coolant	2.5xD Bohrer mit IK	2.5xD Foret avec trous de Lubrification
	3835	M4 ÷ M12	Punta 3.5xD con fori	3.5xD Drill with internal coolant	3.5xD Bohrer mit IK	3.5xD Foret avec trous de lubrification

	Acciaio Steel Stahl Acier	Acciaio Temprato Hardened Steel Gehärteter Stahl Acier trempé	Ghisa Cast Iron Gusseisen Fonte	Acciaio Inox Stainless Steel Edelstahl Acier Inoxydable	HRSA - Titanio HRSA - Titanium HRSA - Titan HRSA - Titane	Metalli non ferrosi Non-ferrous metals NE-Metalle Matières non ferreuses	NON ISO Not ISO Keine ISO Pas d'ISO	Pagina / Page Seite / Page
	P	H	K	M	S	N	O	
	•	-	•	•	•	-	-	60
	•	-	•	•	•	-	-	64
	•	-	•	•	•	-	-	68
	-	-	-	-	-	•	-	72
	-	-	-	-	-	•	-	74
	-	-	-	-	-	•	-	75
	-	-	-	-	-	•	-	75
	•	-	•	•	•	-	-	76
	•	-	•	•	•	-	-	77



PHC

Punte a Centrare
Center Drills
Zentrierbohrungen
Forets à centrer

	Codice Code	Ø (D mm)	Descrizione	Description	Beschreibung	Description
	351	1,0 ÷ 5,0	Punte a centrare 118°	Center Drills 118°	Zentrierbohrer 118°	Forets à centrer 118°
	357	3,0 ÷ 16,0	Punte a centrare 90°	Center Drills 90°	Zentrierbohrer 90°	Forets à centrer 90°
	358	3,0 ÷ 12,0	Punte a centrare 120°	Center Drills 120°	Zentrierbohrer 120°	Forets à centrer 120°

ALR

Alesatori Centesimali
Reamers
Hundertstel-Reibahlen
Alésoirs centésimales

	502	2,97 ÷ 18,20	Alesatori centesimali extracorti	Extra-short reamers	Extra kurze Hundertstel-Reibahle	Alésoirs au centième extra-courts
	503	0,90 ÷ 20,20	Alesatori centesimali standard	Standard reamers	Standard Hundertstel-Reibahle	Alésoirs au centième standards
	504	2,00 ÷ 12,20	Alesatori centesimali extralunghi	Extra-long reamers	Extra lange Hundertstel-Reibahle	Alésoirs au centième extra-longs

PARTE TECNICA

TECHNICAL SECTION / TECHNISCHER TEIL / SECTION TECHNIQUE

PARAMETRI DI LAVORO

WORKING PARAMETERS / BEARBEITUNGSPARAMETER / PARAMÈTRES D'USINAGE

PROCEDURA DI FORATURA PROFONDA PER PUNTE 15-30xD

DEEP DRILLING PROCEDURE FOR 15-30xD DRILLS / TIEFBOHRPROZESS FÜR 15-30xD BOHRER / PROCEDURE DE PÉRÇAGE PROFOND POUR FORETS 15-30xD

OPZIONI A RICHIESTA

OPTIONS UPON REQUEST

	Acciaio Steel Stahl Acier	Acciaio Temprato Hardened Steel Gehärteter Stahl Acier trempé	Ghisa Cast Iron Gusseisen Fonte	Acciaio Inox Stainless Steel Edelstahl Acier Inoxydable	HRSA - Titanio HRSA - Titanium HRSA - Titan HRSA - Titane	Metalli non ferrosi Non-ferrous metals NE-Metalle Matières non ferreuses	NON ISO Not ISO Keine ISO Pas d'ISO	Pagina / Page Seite / Page
	P	H	K	M	S	N	O	
	•	-	•	•	•	•	-	78
	•	-	•	•	•	•	-	79
	•	-	•	•	•	•	-	80
	•	•	•	•	•	•	-	83
	•	•	•	•	•	•	-	84
	•	•	•	•	•	•	-	86
								88
								100
								102

Scansiona il codice QR per scaricare la versione digitale

Scan QR code to download the digital version



PUNTE HM PER ACCIAIO FINO 12xD

HM DRILLS FOR STEEL UP TO 12xD / HM-BOHRER FÜR STAHL BIS 12xD / FORETS HM POUR ACIER JUSQU'À 12xD

3030A

Punta 3xD senza fori

3xD Drill without internal coolant

3xD Bohrer ohne IK

3xD Foret sans trous de lubrification



DIN
6537K

DIN
6535 HA
(Standard)



P

K

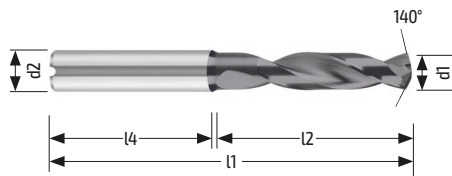

140°	d1 m7	d2 h6	lu	l2	l4	l1	X-Pro Coating	Stock
	3,00	6	14	20	36	62	HMX3030A030	●
	3,10	6	14	20	36	62	HMX3030A031	●
	3,20	6	14	20	36	62	HMX3030A032	●
	3,30	6	14	20	36	62	HMX3030A033	●
	3,40	6	14	20	36	62	HMX3030A034	●
	3,50	6	14	20	36	62	HMX3030A035	●
	3,60	6	14	20	36	62	HMX3030A036	●
	3,70	6	14	20	36	62	HMX3030A037	●
	3,80	6	17	24	36	66	HMX3030A038	●
	3,90	6	17	24	36	66	HMX3030A039	●
	4,00	6	17	24	36	66	HMX3030A040	●
	4,10	6	17	24	36	66	HMX3030A041	●
	4,20	6	17	24	36	66	HMX3030A042	●
	4,30	6	17	24	36	66	HMX3030A043	●
	4,40	6	17	24	36	66	HMX3030A044	●
	4,50	6	17	24	36	66	HMX3030A045	●
	4,60	6	17	24	36	66	HMX3030A046	●
	4,70	6	17	24	36	66	HMX3030A047	●
	4,80	6	20	28	36	66	HMX3030A048	●
	4,90	6	20	28	36	66	HMX3030A049	●
	5,00	6	20	28	36	66	HMX3030A050	●
	5,10	6	20	28	36	66	HMX3030A051	●
	5,20	6	20	28	36	66	HMX3030A052	●
	5,30	6	20	28	36	66	HMX3030A053	●

P

Acciaio
Steel
Stahl
Acier

H

Acciaio Temprato
Hardened Steel
Gehärteter Stahl
Acier trempé

K

Ghisa
Cast Iron
Gusseisen
Fonte

M

Acciaio Inox
Stainless Steel
Edelstahl
Acier Inoxydable

S

HRSA - Titanio
HRSA - Titanium
HRSA - Titan
HRSA - Titane

N

Metalli non ferrosi
Non-ferrous metals
NE-Metalle
Matières non ferreuses

O

NON ISO
Not ISO
Keine ISO
Pas d'ISO

● Disponibilità pronta consegna
Availability for prompt delivery

● Consegna 5 giorni data ordine
Delivery 5 days order date

○ Disponibilità su richiesta
Availability on request

140°

d1 m7	d2 h6	lu	l2	l4	l1	X-Pro Coating	Stock
5,40	6	20	28	36	66	HMX3030A054	●
5,50	6	20	28	36	66	HMX3030A055	●
5,60	6	20	28	36	66	HMX3030A056	●
5,70	6	20	28	36	66	HMX3030A057	●
5,80	6	20	28	36	66	HMX3030A058	●
5,90	6	20	28	36	66	HMX3030A059	●
6,00	6	20	28	36	66	HMX3030A060	●
6,10	8	24	34	36	79	HMX3030A061	●
6,20	8	24	34	36	79	HMX3030A062	●
6,30	8	24	34	36	79	HMX3030A063	●
6,40	8	24	34	36	79	HMX3030A064	●
6,50	8	24	34	36	79	HMX3030A065	●
6,60	8	24	34	36	79	HMX3030A066	●
6,70	8	24	34	36	79	HMX3030A067	●
6,80	8	24	34	36	79	HMX3030A068	●
6,90	8	24	34	36	79	HMX3030A069	●
7,00	8	24	34	36	79	HMX3030A070	●
7,10	8	29	41	36	79	HMX3030A071	○
7,20	8	29	41	36	79	HMX3030A072	●
7,30	8	29	41	36	79	HMX3030A073	○
7,40	8	29	41	36	79	HMX3030A074	●
7,50	8	29	41	36	79	HMX3030A075	●
7,60	8	29	41	36	79	HMX3030A076	○
7,70	8	29	41	36	79	HMX3030A077	●
7,80	8	29	41	36	79	HMX3030A078	●
7,90	8	29	41	36	79	HMX3030A079	●
8,00	8	29	41	36	79	HMX3030A080	●
8,10	10	35	47	40	89	HMX3030A081	●
8,20	10	35	47	40	89	HMX3030A082	●
8,30	10	35	47	40	89	HMX3030A083	●
8,40	10	35	47	40	89	HMX3030A084	○
8,50	10	35	47	40	89	HMX3030A085	●
8,60	10	35	47	40	89	HMX3030A086	●
8,70	10	35	47	40	89	HMX3030A087	●
8,80	10	35	47	40	89	HMX3030A088	●
8,90	10	35	47	40	89	HMX3030A089	●
9,00	10	35	47	40	89	HMX3030A090	●
9,10	10	35	47	40	89	HMX3030A091	●
9,20	10	35	47	40	89	HMX3030A092	○
9,30	10	35	47	40	89	HMX3030A093	●
9,40	10	35	47	40	89	HMX3030A094	○
9,50	10	35	47	40	89	HMX3030A095	●
9,60	10	35	47	40	89	HMX3030A096	○
9,70	10	35	47	40	89	HMX3030A097	●
9,80	10	35	47	40	89	HMX3030A098	●
9,90	10	35	47	40	89	HMX3030A099	●
10,00	10	35	47	40	89	HMX3030A100	●
10,10	12	40	55	45	102	HMX3030A101	○
10,20	12	40	55	45	102	HMX3030A102	●
10,30	12	40	55	45	102	HMX3030A103	○
10,40	12	40	55	45	102	HMX3030A104	○
10,50	12	40	55	45	102	HMX3030A105	●
10,60	12	40	55	45	102	HMX3030A106	●
10,70	12	40	55	45	102	HMX3030A107	○
10,80	12	40	55	45	102	HMX3030A108	●
10,90	12	40	55	45	102	HMX3030A109	○
11,00	12	40	55	45	102	HMX3030A110	●
11,10	12	40	55	45	102	HMX3030A111	○
11,20	12	40	55	45	102	HMX3030A112	○
11,30	12	40	55	45	102	HMX3030A113	●
11,40	12	40	55	45	102	HMX3030A114	●
11,50	12	40	55	45	102	HMX3030A115	●

3030A

Punta 3xD senza fori
 3xD Drill without internal coolant
 3xD Bohrer ohne IK
 3xD Foret sans trous de lubrification



DIN
6537K

DIN
6535 HA
(Standard)



P

K

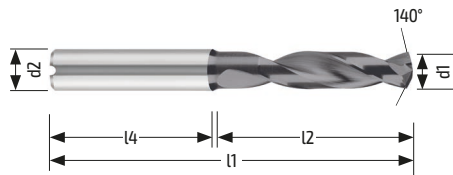

140°

d1 m7	d2 h6	lu	l2	l4	l1	X-Pro Coating	Stock
11,60	12	40	55	45	102	HMX3030A116	○
11,70	12	40	55	45	102	HMX3030A117	●
11,80	12	40	55	45	102	HMX3030A118	●
11,90	12	40	55	45	102	HMX3030A119	●
12,00	12	40	55	45	102	HMX3030A120	●
12,10	14	43	60	45	107	HMX3030A121	○
12,20	14	43	60	45	107	HMX3030A122	○
12,30	14	43	60	45	107	HMX3030A123	●
12,40	14	43	60	45	107	HMX3030A124	○
12,50	14	43	60	45	107	HMX3030A125	●
12,60	14	43	60	45	107	HMX3030A126	○
12,70	14	43	60	45	107	HMX3030A127	○
12,80	14	43	60	45	107	HMX3030A128	●
12,90	14	43	60	45	107	HMX3030A129	○
13,00	14	43	60	45	107	HMX3030A130	●
13,10	14	43	60	45	107	HMX3030A131	○
13,20	14	43	60	45	107	HMX3030A132	○
13,30	14	43	60	45	107	HMX3030A133	○
13,40	14	43	60	45	107	HMX3030A134	○
13,50	14	43	60	45	107	HMX3030A135	●
13,60	14	43	60	45	107	HMX3030A136	○
13,70	14	43	60	45	107	HMX3030A137	○
13,80	14	43	60	45	107	HMX3030A138	●
13,90	14	43	60	45	107	HMX3030A139	○
14,00	14	43	60	45	107	HMX3030A140	●
14,10	16	45	65	48	115	HMX3030A141	●
14,20	16	45	65	48	115	HMX3030A142	●
14,30	16	45	65	48	115	HMX3030A143	○
14,40	16	45	65	48	115	HMX3030A144	○
14,50	16	45	65	48	115	HMX3030A145	●
14,60	16	45	65	48	115	HMX3030A146	○
14,70	16	45	65	48	115	HMX3030A147	○
14,80	16	45	65	48	115	HMX3030A148	●
14,90	16	45	65	48	115	HMX3030A149	○
15,00	16	45	65	48	115	HMX3030A150	●
15,10	16	45	65	48	115	HMX3030A151	●
15,20	16	45	65	48	115	HMX3030A152	○
15,30	16	45	65	48	115	HMX3030A153	●
15,40	16	45	65	48	115	HMX3030A154	○
15,50	16	45	65	48	115	HMX3030A155	●
15,60	16	45	65	48	115	HMX3030A156	○
15,70	16	45	65	48	115	HMX3030A157	○
15,80	16	45	65	48	115	HMX3030A158	●
15,90	16	45	65	48	115	HMX3030A159	○
16,00	16	45	65	48	115	HMX3030A160	●
16,10	18	52	73	48	123	HMX3030A161	○

140°

d1 m7	d2 h6	lu	l2	l4	l1	X-Pro Coating	Stock
16,20	18	52	73	48	123	HMX3030A162	○
16,30	18	52	73	48	123	HMX3030A163	○
16,40	18	52	73	48	123	HMX3030A164	○
16,50	18	52	73	48	123	HMX3030A165	○
16,60	18	52	73	48	123	HMX3030A166	○
16,70	18	52	73	48	123	HMX3030A167	○
16,80	18	52	73	48	123	HMX3030A168	○
16,90	18	52	73	48	123	HMX3030A169	○
17,00	18	52	73	48	123	HMX3030A170	○
17,10	18	52	73	48	123	HMX3030A171	○
17,20	18	52	73	48	123	HMX3030A172	○
17,30	18	52	73	48	123	HMX3030A173	○
17,40	18	52	73	48	123	HMX3030A174	○
17,50	18	52	73	48	123	HMX3030A175	○
17,60	18	52	73	48	123	HMX3030A176	○
17,70	18	52	73	48	123	HMX3030A177	○
17,80	18	52	73	48	123	HMX3030A178	○
17,90	18	52	73	48	123	HMX3030A179	○
18,00	18	52	73	48	123	HMX3030A180	○
18,10	20	57	79	50	131	HMX3030A181	○
18,20	20	57	79	50	131	HMX3030A182	○
18,30	20	57	79	50	131	HMX3030A183	○
18,40	20	57	79	50	131	HMX3030A184	○
18,50	20	57	79	50	131	HMX3030A185	○
18,60	20	57	79	50	131	HMX3030A186	○
18,70	20	57	79	50	131	HMX3030A187	○
18,80	20	57	79	50	131	HMX3030A188	○
18,90	20	57	79	50	131	HMX3030A189	○
19,00	20	57	79	50	131	HMX3030A190	○
19,10	20	57	79	50	131	HMX3030A191	○
19,20	20	57	79	50	131	HMX3030A192	○
19,30	20	57	79	50	131	HMX3030A193	○
19,40	20	57	79	50	131	HMX3030A194	○
19,50	20	57	79	50	131	HMX3030A195	○
19,60	20	57	79	50	131	HMX3030A196	○
19,70	20	57	79	50	131	HMX3030A197	○
19,80	20	57	79	50	131	HMX3030A198	○
19,90	20	57	79	50	131	HMX3030A199	○
20,00	20	57	79	50	131	HMX3030A200	○

3031A

Punta 3xD con fori
3xD Drill with internal coolant
3xD Bohrer mit IK
3xD Foret avec trous de lubrification

DIN
6537KDIN
6535 HA
(Standard)

P

K

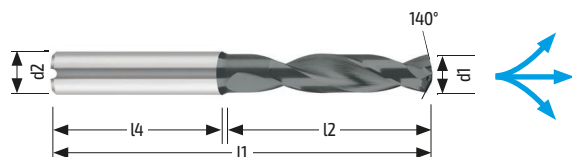

140°

d1 m7	d2 h6	lu	l2	l4	l1	X-Pro Coating	Stock
3,00	6	14	20	36	62	HMX3031A030	●
3,10	6	14	20	36	62	HMX3031A031	●
3,20	6	14	20	36	62	HMX3031A032	●
3,30	6	14	20	36	62	HMX3031A033	●
3,40	6	14	20	36	62	HMX3031A034	●
3,50	6	14	20	36	62	HMX3031A035	●
3,60	6	14	20	36	62	HMX3031A036	●
3,70	6	14	20	36	62	HMX3031A037	●
3,80	6	17	24	36	66	HMX3031A038	●
3,90	6	17	24	36	66	HMX3031A039	●
4,00	6	17	24	36	66	HMX3031A040	●
4,10	6	17	24	36	66	HMX3031A041	●
4,20	6	17	24	36	66	HMX3031A042	●
4,30	6	17	24	36	66	HMX3031A043	●
4,40	6	17	24	36	66	HMX3031A044	●
4,50	6	17	24	36	66	HMX3031A045	●
4,60	6	17	24	36	66	HMX3031A046	●
4,70	6	17	24	36	66	HMX3031A047	●
4,80	6	20	28	36	66	HMX3031A048	●
4,90	6	20	28	36	66	HMX3031A049	●
5,00	6	20	28	36	66	HMX3031A050	●
5,10	6	20	28	36	66	HMX3031A051	●
5,20	6	20	28	36	66	HMX3031A052	●
5,30	6	20	28	36	66	HMX3031A053	●
5,40	6	20	28	36	66	HMX3031A054	●
5,50	6	20	28	36	66	HMX3031A055	●
5,60	6	20	28	36	66	HMX3031A056	●
5,70	6	20	28	36	66	HMX3031A057	●
5,80	6	20	28	36	66	HMX3031A058	●
5,90	6	20	28	36	66	HMX3031A059	●
6,00	6	20	28	36	66	HMX3031A060	●
6,10	8	24	34	36	79	HMX3031A061	●
6,20	8	24	34	36	79	HMX3031A062	●
6,30	8	24	34	36	79	HMX3031A063	●
6,40	8	24	34	36	79	HMX3031A064	●
6,50	8	24	34	36	79	HMX3031A065	●

P

Acciaio
Steel
Stahl
Acier

H

Acciaio Temprato
Hardened Steel
Gehärteter Stahl
Acier trempé

K

Ghisa
Cast Iron
Gusseisen
Fonte

M

Acciaio Inox
Stainless Steel
Edelstahl
Acier Inoxydable

S

HRSA - Titanio
HRSA - Titanium
HRSA - Titan
HRSA - Titane

N

Metalli non ferrosi
Non-ferrous metals
NE-Metalle
Matières non ferreuses

O

NON ISO
Not ISO
Keine ISO
Pas d'ISO

● Disponibilità pronta consegna
Availability for prompt delivery

⦿ Consegna 5 giorni data ordine
Delivery 5 days order date

○ Disponibilità su richiesta
Availability on request

140°

d1 m7	d2 h6	lu	l2	l4	l1	X-Pro Coating	Stock
6,60	8	24	34	36	79	HMX3031A066	●
6,70	8	24	34	36	79	HMX3031A067	●
6,80	8	24	34	36	79	HMX3031A068	●
6,90	8	24	34	36	79	HMX3031A069	●
7,00	8	24	34	36	79	HMX3031A070	●
7,10	8	29	41	36	79	HMX3031A071	●
7,20	8	29	41	36	79	HMX3031A072	●
7,30	8	29	41	36	79	HMX3031A073	●
7,40	8	29	41	36	79	HMX3031A074	●
7,50	8	29	41	36	79	HMX3031A075	●
7,60	8	29	41	36	79	HMX3031A076	●
7,70	8	29	41	36	79	HMX3031A077	●
7,80	8	29	41	36	79	HMX3031A078	●
7,90	8	29	41	36	79	HMX3031A079	●
8,00	8	29	41	36	79	HMX3031A080	●
8,10	10	35	47	40	89	HMX3031A081	●
8,20	10	35	47	40	89	HMX3031A082	●
8,30	10	35	47	40	89	HMX3031A083	●
8,40	10	35	47	40	89	HMX3031A084	●
8,50	10	35	47	40	89	HMX3031A085	●
8,60	10	35	47	40	89	HMX3031A086	●
8,70	10	35	47	40	89	HMX3031A087	●
8,80	10	35	47	40	89	HMX3031A088	●
8,90	10	35	47	40	89	HMX3031A089	●
9,00	10	35	47	40	89	HMX3031A090	●
9,10	10	35	47	40	89	HMX3031A091	●
9,20	10	35	47	40	89	HMX3031A092	●
9,30	10	35	47	40	89	HMX3031A093	●
9,40	10	35	47	40	89	HMX3031A094	●
9,50	10	35	47	40	89	HMX3031A095	●
9,60	10	35	47	40	89	HMX3031A096	●
9,70	10	35	47	40	89	HMX3031A097	●
9,80	10	35	47	40	89	HMX3031A098	●
9,90	10	35	47	40	89	HMX3031A099	●
10,00	10	35	47	40	89	HMX3031A100	●
10,10	12	40	55	45	102	HMX3031A101	●
10,20	12	40	55	45	102	HMX3031A102	●
10,30	12	40	55	45	102	HMX3031A103	●
10,40	12	40	55	45	102	HMX3031A104	●
10,50	12	40	55	45	102	HMX3031A105	●
10,60	12	40	55	45	102	HMX3031A106	●
10,70	12	40	55	45	102	HMX3031A107	●
10,80	12	40	55	45	102	HMX3031A108	●
10,90	12	40	55	45	102	HMX3031A109	●
11,00	12	40	55	45	102	HMX3031A110	●
11,10	12	40	55	45	102	HMX3031A111	●
11,20	12	40	55	45	102	HMX3031A112	●
11,30	12	40	55	45	102	HMX3031A113	●
11,40	12	40	55	45	102	HMX3031A114	●
11,50	12	40	55	45	102	HMX3031A115	●
11,60	12	40	55	45	102	HMX3031A116	●
11,70	12	40	55	45	102	HMX3031A117	●
11,80	12	40	55	45	102	HMX3031A118	●
11,90	12	40	55	45	102	HMX3031A119	●
12,00	12	40	55	45	102	HMX3031A120	●
12,10	14	43	60	45	107	HMX3031A121	●
12,20	14	43	60	45	107	HMX3031A122	●
12,30	14	43	60	45	107	HMX3031A123	○
12,40	14	43	60	45	107	HMX3031A124	○
12,50	14	43	60	45	107	HMX3031A125	○
12,60	14	43	60	45	107	HMX3031A126	○
12,70	14	43	60	45	107	HMX3031A127	○
12,80	14	43	60	45	107	HMX3031A128	●
12,90	14	43	60	45	107	HMX3031A129	○

3031A

Punta 3xD con fori
 3xD Drill with internal coolant
 3xD Bohrer mit IK
 3xD Foret avec trous de lubrification



DIN
6537K

DIN
6535 HA
(Standard)



P

K

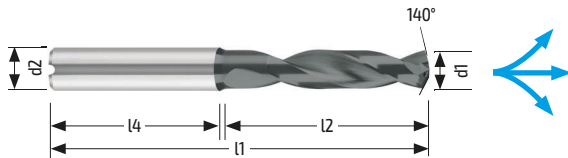

140°

d1 m7	d2 h6	lu	l2	l4	l1	X-Pro Coating	Stock
13,00	14	43	60	45	107	HMX3031A130	●
13,10	14	43	60	45	107	HMX3031A131	○
13,20	14	43	60	45	107	HMX3031A132	○
13,30	14	43	60	45	107	HMX3031A133	○
13,40	14	43	60	45	107	HMX3031A134	○
13,50	14	43	60	45	107	HMX3031A135	○
13,60	14	43	60	45	107	HMX3031A136	○
13,70	14	43	60	45	107	HMX3031A137	○
13,80	14	43	60	45	107	HMX3031A138	●
13,90	14	43	60	45	107	HMX3031A139	○
14,00	14	43	60	45	107	HMX3031A140	●
14,10	16	45	65	48	115	HMX3031A141	○
14,20	16	45	65	48	115	HMX3031A142	●
14,30	16	45	65	48	115	HMX3031A143	○
14,40	16	45	65	48	115	HMX3031A144	○
14,50	16	45	65	48	115	HMX3031A145	●
14,60	16	45	65	48	115	HMX3031A146	○
14,70	16	45	65	48	115	HMX3031A147	○
14,80	16	45	65	48	115	HMX3031A148	●
14,90	16	45	65	48	115	HMX3031A149	○
15,00	16	45	65	48	115	HMX3031A150	●
15,10	16	45	65	48	115	HMX3031A151	○
15,20	16	45	65	48	115	HMX3031A152	○
15,30	16	45	65	48	115	HMX3031A153	○
15,40	16	45	65	48	115	HMX3031A154	○
15,50	16	45	65	48	115	HMX3031A155	●
15,60	16	45	65	48	115	HMX3031A156	○
15,70	16	45	65	48	115	HMX3031A157	○
15,80	16	45	65	48	115	HMX3031A158	●
15,90	16	45	65	48	115	HMX3031A159	○
16,00	16	45	65	48	115	HMX3031A160	●
16,10	18	52	73	48	123	HMX3031A161	○
16,20	18	52	73	48	123	HMX3031A162	○
16,30	18	52	73	48	123	HMX3031A163	○
16,40	18	52	73	48	123	HMX3031A164	○
16,50	18	52	73	48	123	HMX3031A165	●
16,60	18	52	73	48	123	HMX3031A166	○
16,70	18	52	73	48	123	HMX3031A167	○
16,80	18	52	73	48	123	HMX3031A168	○
16,90	18	52	73	48	123	HMX3031A169	○
17,00	18	52	73	48	123	HMX3031A170	●
17,10	18	52	73	48	123	HMX3031A171	○
17,20	18	52	73	48	123	HMX3031A172	○
17,30	18	52	73	48	123	HMX3031A173	○
17,40	18	52	73	48	123	HMX3031A174	○
17,50	18	52	73	48	123	HMX3031A175	●
17,60	18	52	73	48	123	HMX3031A176	○
17,70	18	52	73	48	123	HMX3031A177	○



d1 m7	d2 h6	lu	l2	l4	l1	X-Pro Coating	Stock
17,80	18	52	73	48	123	HMX3031A178	○
17,90	18	52	73	48	123	HMX3031A179	○
18,00	18	52	73	48	123	HMX3031A180	●
18,10	20	57	79	50	131	HMX3031A181	○
18,20	20	57	79	50	131	HMX3031A182	○
18,30	20	57	79	50	131	HMX3031A183	○
18,40	20	57	79	50	131	HMX3031A184	○
18,50	20	57	79	50	131	HMX3031A185	●
18,60	20	57	79	50	131	HMX3031A186	○
18,70	20	57	79	50	131	HMX3031A187	○
18,80	20	57	79	50	131	HMX3031A188	○
18,90	20	57	79	50	131	HMX3031A189	○
19,00	20	57	79	50	131	HMX3031A190	●
19,10	20	57	79	50	131	HMX3031A191	○
19,20	20	57	79	50	131	HMX3031A192	○
19,30	20	57	79	50	131	HMX3031A193	○
19,40	20	57	79	50	131	HMX3031A194	○
19,50	20	57	79	50	131	HMX3031A195	●
19,60	20	57	79	50	131	HMX3031A196	○
19,70	20	57	79	50	131	HMX3031A197	○
19,80	20	57	79	50	131	HMX3031A198	○
19,90	20	57	79	50	131	HMX3031A199	○
20,00	20	57	79	50	131	HMX3031A200	●

Notes _____

3050A

Punta 5xD senza fori
5xD Drill without internal coolant
5xD Bohrer ohne IK
5xD Foret sans trous de lubrification

DIN
6537LDIN
6535 HA
(Standard)

P

K



140°

d1 m7	d2 h6	lu	l2	l4	l1	X-Pro Coating	Stock
3,00	6	23	27	36	66	HMX3050A030	●
3,10	6	23	27	36	66	HMX3050A031	●
3,20	6	23	27	36	66	HMX3050A032	●
3,30	6	23	27	36	66	HMX3050A033	●
3,40	6	23	27	36	66	HMX3050A034	●
3,50	6	23	27	36	66	HMX3050A035	●
3,60	6	23	27	36	66	HMX3050A036	●
3,70	6	23	27	36	66	HMX3050A037	●
3,80	6	29	36	36	74	HMX3050A038	●
3,90	6	29	36	36	74	HMX3050A039	●
4,00	6	29	36	36	74	HMX3050A040	●
4,10	6	29	36	36	74	HMX3050A041	●
4,20	6	29	36	36	74	HMX3050A042	●
4,30	6	29	36	36	74	HMX3050A043	●
4,40	6	29	36	36	74	HMX3050A044	●
4,50	6	29	36	36	74	HMX3050A045	●
4,60	6	29	36	36	74	HMX3050A046	●
4,70	6	29	36	36	74	HMX3050A047	●
4,80	6	35	44	36	82	HMX3050A048	●
4,90	6	35	44	36	82	HMX3050A049	●
5,00	6	35	44	36	82	HMX3050A050	●
5,10	6	35	44	36	82	HMX3050A051	●
5,20	6	35	44	36	82	HMX3050A052	●
5,30	6	35	44	36	82	HMX3050A053	●
5,40	6	35	44	36	82	HMX3050A054	●
5,50	6	35	44	36	82	HMX3050A055	●
5,60	6	35	44	36	82	HMX3050A056	●
5,70	6	35	44	36	82	HMX3050A057	●
5,80	6	35	44	36	82	HMX3050A058	●
5,90	6	35	44	36	82	HMX3050A059	●
6,00	6	35	44	36	82	HMX3050A060	●
6,10	8	43	53	36	91	HMX3050A061	●
6,20	8	43	53	36	91	HMX3050A062	○
6,30	8	43	53	36	91	HMX3050A063	●
6,40	8	43	53	36	91	HMX3050A064	○
6,50	8	43	53	36	91	HMX3050A065	●

P

Acciaio
Steel
Stahl
Acier

H

Acciaio Temprato
Hardened Steel
Gehärteter Stahl
Acier trempé

K

Ghisa
Cast Iron
Gusseisen
Fonte

M

Acciaio Inox
Stainless Steel
Edelstahl
Acier Inoxydable

S

HRSA - Titanio
HRSA - Titanium
HRSA - Titan
HRSA - Titane

N

Metalli non ferrosi
Non-ferrous metals
NE-Metalle
Matières non ferreuses

O

NON ISO
Not ISO
Keine ISO
Pas d'ISO

● Disponibilità pronta consegna
Availability for prompt delivery

○ Consegna 5 giorni data ordine
Delivery 5 days order date

○ Disponibilità su richiesta
Availability on request

140°

d1 m7	d2 h6	lu	l2	l4	l1	X-Pro Coating	Stock
6,60	8	43	53	36	91	HMX3050A066	○
6,70	8	43	53	36	91	HMX3050A067	○
6,80	8	43	53	36	91	HMX3050A068	●
6,90	8	43	53	36	91	HMX3050A069	●
7,00	8	43	53	36	91	HMX3050A070	●
7,10	8	43	53	36	91	HMX3050A071	○
7,20	8	43	53	36	91	HMX3050A072	○
7,30	8	43	53	36	91	HMX3050A073	○
7,40	8	43	53	36	91	HMX3050A074	●
7,50	8	43	53	36	91	HMX3050A075	●
7,60	8	43	53	36	91	HMX3050A076	○
7,70	8	43	53	36	91	HMX3050A077	○
7,80	8	43	53	36	91	HMX3050A078	●
7,90	8	43	53	36	91	HMX3050A079	○
8,00	8	43	53	36	91	HMX3050A080	●
8,10	10	49	61	40	103	HMX3050A081	○
8,20	10	49	61	40	103	HMX3050A082	○
8,30	10	49	61	40	103	HMX3050A083	○
8,40	10	49	61	40	103	HMX3050A084	○
8,50	10	49	61	40	103	HMX3050A085	●
8,60	10	49	61	40	103	HMX3050A086	●
8,70	10	49	61	40	103	HMX3050A087	●
8,80	10	49	61	40	103	HMX3050A088	●
8,90	10	49	61	40	103	HMX3050A089	●
9,00	10	49	61	40	103	HMX3050A090	●
9,10	10	49	61	40	103	HMX3050A091	○
9,20	10	49	61	40	103	HMX3050A092	○
9,30	10	49	61	40	103	HMX3050A093	●
9,40	10	49	61	40	103	HMX3050A094	○
9,50	10	49	61	40	103	HMX3050A095	●
9,60	10	49	61	40	103	HMX3050A096	○
9,70	10	49	61	40	103	HMX3050A097	○
9,80	10	49	61	40	103	HMX3050A098	●
9,90	10	49	61	40	103	HMX3050A099	○
10,00	10	49	61	40	103	HMX3050A100	●
10,10	12	56	71	45	118	HMX3050A101	○
10,20	12	56	71	45	118	HMX3050A102	●
10,30	12	56	71	45	118	HMX3050A103	○
10,40	12	56	71	45	118	HMX3050A104	○
10,50	12	56	71	45	118	HMX3050A105	●
10,60	12	56	71	45	118	HMX3050A106	●
10,70	12	56	71	45	118	HMX3050A107	○
10,80	12	56	71	45	118	HMX3050A108	●
10,90	12	56	71	45	118	HMX3050A109	○
11,00	12	56	71	45	118	HMX3050A110	●
11,10	12	56	71	45	118	HMX3050A111	○
11,20	12	56	71	45	118	HMX3050A112	●
11,30	12	56	71	45	118	HMX3050A113	○
11,40	12	56	71	45	118	HMX3050A114	○
11,50	12	56	71	45	118	HMX3050A115	●
11,60	12	56	71	45	118	HMX3050A116	○
11,70	12	56	71	45	118	HMX3050A117	○
11,80	12	56	71	45	118	HMX3050A118	●
11,90	12	56	71	45	118	HMX3050A119	●
12,00	12	56	71	45	118	HMX3050A120	●
12,10	14	60	77	45	124	HMX3050A121	○
12,20	14	60	77	45	124	HMX3050A122	●
12,30	14	60	77	45	124	HMX3050A123	○
12,40	14	60	77	45	124	HMX3050A124	○
12,50	14	60	77	45	124	HMX3050A125	●
12,60	14	60	77	45	124	HMX3050A126	●
12,70	14	60	77	45	124	HMX3050A127	●
12,80	14	60	77	45	124	HMX3050A128	●
12,90	14	60	77	45	124	HMX3050A129	○

3050A

Punta 5xD senza fori
 5xD Drill without internal coolant
 5xD Bohrer ohne IK
 5xD Foret sans trous de lubrification



DIN
6537L

DIN
6535 HA
(Standard)



P

K

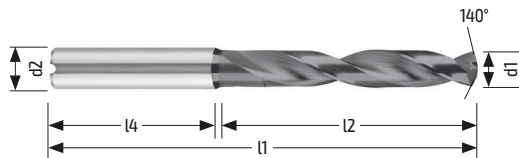

140°

d1 m7	d2 h6	lu	l2	l4	l1	X-Pro Coating	Stock
13,00	14	60	77	45	124	HMX3050A130	●
13,10	14	60	77	45	124	HMX3050A131	○
13,20	14	60	77	45	124	HMX3050A132	○
13,30	14	60	77	45	124	HMX3050A133	○
13,40	14	60	77	45	124	HMX3050A134	○
13,50	14	60	77	45	124	HMX3050A135	●
13,60	14	60	77	45	124	HMX3050A136	○
13,70	14	60	77	45	124	HMX3050A137	○
13,80	14	60	77	45	124	HMX3050A138	●
13,90	14	60	77	45	124	HMX3050A139	○
14,00	14	60	77	45	124	HMX3050A140	●
14,10	16	63	83	48	133	HMX3050A141	○
14,20	16	63	83	48	133	HMX3050A142	○
14,30	16	63	83	48	133	HMX3050A143	○
14,40	16	63	83	48	133	HMX3050A144	○
14,50	16	63	83	48	133	HMX3050A145	●
14,60	16	63	83	48	133	HMX3050A146	○
14,70	16	63	83	48	133	HMX3050A147	○
14,80	16	63	83	48	133	HMX3050A148	●
14,90	16	63	83	48	133	HMX3050A149	○
15,00	16	63	83	48	133	HMX3050A150	●
15,10	16	63	83	48	133	HMX3050A151	○
15,20	16	63	83	48	133	HMX3050A152	○
15,30	16	63	83	48	133	HMX3050A153	○
15,40	16	63	83	48	133	HMX3050A154	○
15,50	16	63	83	48	133	HMX3050A155	●
15,60	16	63	83	48	133	HMX3050A156	○
15,70	16	63	83	48	133	HMX3050A157	○
15,80	16	63	83	48	133	HMX3050A158	●
15,90	16	63	83	48	133	HMX3050A159	○
16,00	16	63	83	48	133	HMX3050A160	●
16,10	18	72	93	48	143	HMX3050A161	○
16,20	18	72	93	48	143	HMX3050A162	○
16,30	18	72	93	48	143	HMX3050A163	○
16,40	18	72	93	48	143	HMX3050A164	○
16,50	18	72	93	48	143	HMX3050A165	○
16,60	18	72	93	48	143	HMX3050A166	○
16,70	18	72	93	48	143	HMX3050A167	○
16,80	18	72	93	48	143	HMX3050A168	○
16,90	18	72	93	48	143	HMX3050A169	○
17,00	18	72	93	48	143	HMX3050A170	○
17,10	18	72	93	48	143	HMX3050A171	○
17,20	18	72	93	48	143	HMX3050A172	○
17,30	18	72	93	48	143	HMX3050A173	○
17,40	18	72	93	48	143	HMX3050A174	○
17,50	18	72	93	48	143	HMX3050A175	○
17,60	18	72	93	48	143	HMX3050A176	○
17,70	18	72	93	48	143	HMX3050A177	○

140°

d1 m7	d2 h6	lu	l2	l4	l1	X-Pro Coating	Stock
17,80	18	72	93	48	143	HMX3050A178	○
17,90	18	72	93	48	143	HMX3050A179	○
18,00	18	72	93	48	143	HMX3050A180	○
18,10	20	79	101	50	153	HMX3050A181	○
18,20	20	79	101	50	153	HMX3050A182	○
18,30	20	79	101	50	153	HMX3050A183	○
18,40	20	79	101	50	153	HMX3050A184	○
18,50	20	79	101	50	153	HMX3050A185	○
18,60	20	79	101	50	153	HMX3050A186	○
18,70	20	79	101	50	153	HMX3050A187	○
18,80	20	79	101	50	153	HMX3050A188	○
18,90	20	79	101	50	153	HMX3050A189	○
19,00	20	79	101	50	153	HMX3050A190	○
19,10	20	79	101	50	153	HMX3050A191	○
19,20	20	79	101	50	153	HMX3050A192	○
19,30	20	79	101	50	153	HMX3050A193	○
19,40	20	79	101	50	153	HMX3050A194	○
19,50	20	79	101	50	153	HMX3050A195	○
19,60	20	79	101	50	153	HMX3050A196	○
19,70	20	79	101	50	153	HMX3050A197	○
19,80	20	79	101	50	153	HMX3050A198	○
19,90	20	79	101	50	153	HMX3050A199	○
20,00	20	79	101	50	153	HMX3050A200	○

Notes _____

3051A

Punta 5xD con fori
5xD Drill with internal coolant
5xD Bohrer mit IK
5xD Foret avec trous de lubrification



DIN
6537L

DIN
6535 HA
(Standard)



P

K

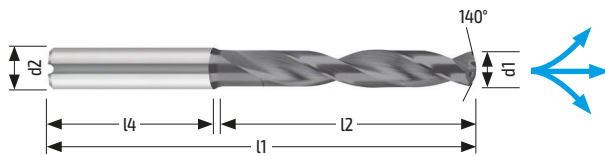

140°

d1 m7	d2 h6	lu	l2	l4	l1	X-Pro Coating	Stock
3,00	6	23	27	36	66	HMX3051A030	●
3,10	6	23	27	36	66	HMX3051A031	●
3,20	6	23	27	36	66	HMX3051A032	●
3,30	6	23	27	36	66	HMX3051A033	●
3,40	6	23	27	36	66	HMX3051A034	●
3,50	6	23	27	36	66	HMX3051A035	●
3,60	6	23	27	36	66	HMX3051A036	●
3,70	6	23	27	36	66	HMX3051A037	●
3,80	6	29	36	36	74	HMX3051A038	●
3,90	6	29	36	36	74	HMX3051A039	●
4,00	6	29	36	36	74	HMX3051A040	●
4,10	6	29	36	36	74	HMX3051A041	●
4,20	6	29	36	36	74	HMX3051A042	●
4,30	6	29	36	36	74	HMX3051A043	●
4,40	6	29	36	36	74	HMX3051A044	●
4,50	6	29	36	36	74	HMX3051A045	●
4,60	6	29	36	36	74	HMX3051A046	●
4,70	6	29	36	36	74	HMX3051A047	●
4,80	6	35	44	36	82	HMX3051A048	●
4,90	6	35	44	36	82	HMX3051A049	●
5,00	6	35	44	36	82	HMX3051A050	●
5,10	6	35	44	36	82	HMX3051A051	●
5,20	6	35	44	36	82	HMX3051A052	●
5,30	6	35	44	36	82	HMX3051A053	●
5,40	6	35	44	36	82	HMX3051A054	●
5,50	6	35	44	36	82	HMX3051A055	●
5,60	6	35	44	36	82	HMX3051A056	●
5,70	6	35	44	36	82	HMX3051A057	●
5,80	6	35	44	36	82	HMX3051A058	●
5,90	6	35	44	36	82	HMX3051A059	●
6,00	6	35	44	36	82	HMX3051A060	●
6,10	8	43	53	36	91	HMX3051A061	●
6,20	8	43	53	36	91	HMX3051A062	●
6,30	8	43	53	36	91	HMX3051A063	●
6,40	8	43	53	36	91	HMX3051A064	●
6,50	8	43	53	36	91	HMX3051A065	●

P

Acciaio
Steel
Stahl
Acier

H

Acciaio Temprato
Hardened Steel
Gehärteter Stahl
Acier trempé

K

Ghisa
Cast Iron
Gusseisen
Fonte

M

Acciaio Inox
Stainless Steel
Edelstahl
Acier Inoxydable

S

HRSA - Titanio
HRSA - Titanium
HRSA - Titan
HRSA - Titane

N

Metalli non ferrosi
Non-ferrous metals
NE-Metalle
Matières non ferreuses

O

NON ISO
Not ISO
Keine ISO
Pas d'ISO

● Disponibilità pronta consegna
Availability for prompt delivery

⌚ Consegna 5 giorni data ordine
Delivery 5 days order date

○ Disponibilità su richiesta
Availability on request

140°

d1 m7	d2 h6	lu	l2	l4	l1	X-Pro Coating	Stock
6,60	8	43	53	36	91	HMX3051A066	●
6,70	8	43	53	36	91	HMX3051A067	●
6,80	8	43	53	36	91	HMX3051A068	●
6,90	8	43	53	36	91	HMX3051A069	●
7,00	8	43	53	36	91	HMX3051A070	●
7,10	8	43	53	36	91	HMX3051A071	●
7,20	8	43	53	36	91	HMX3051A072	●
7,30	8	43	53	36	91	HMX3051A073	●
7,40	8	43	53	36	91	HMX3051A074	●
7,50	8	43	53	36	91	HMX3051A075	●
7,60	8	43	53	36	91	HMX3051A076	●
7,70	8	43	53	36	91	HMX3051A077	●
7,80	8	43	53	36	91	HMX3051A078	●
7,90	8	43	53	36	91	HMX3051A079	●
8,00	8	43	53	36	91	HMX3051A080	●
8,10	10	49	61	40	103	HMX3051A081	●
8,20	10	49	61	40	103	HMX3051A082	●
8,30	10	49	61	40	103	HMX3051A083	●
8,40	10	49	61	40	103	HMX3051A084	●
8,50	10	49	61	40	103	HMX3051A085	●
8,60	10	49	61	40	103	HMX3051A086	●
8,70	10	49	61	40	103	HMX3051A087	●
8,80	10	49	61	40	103	HMX3051A088	●
8,90	10	49	61	40	103	HMX3051A089	●
9,00	10	49	61	40	103	HMX3051A090	●
9,10	10	49	61	40	103	HMX3051A091	●
9,20	10	49	61	40	103	HMX3051A092	●
9,30	10	49	61	40	103	HMX3051A093	●
9,40	10	49	61	40	103	HMX3051A094	●
9,50	10	49	61	40	103	HMX3051A095	●
9,60	10	49	61	40	103	HMX3051A096	●
9,70	10	49	61	40	103	HMX3051A097	●
9,80	10	49	61	40	103	HMX3051A098	●
9,90	10	49	61	40	103	HMX3051A099	●
10,00	10	49	61	40	103	HMX3051A100	●
10,10	12	56	71	45	118	HMX3051A101	●
10,20	12	56	71	45	118	HMX3051A102	●
10,30	12	56	71	45	118	HMX3051A103	●
10,40	12	56	71	45	118	HMX3051A104	●
10,50	12	56	71	45	118	HMX3051A105	●
10,60	12	56	71	45	118	HMX3051A106	●
10,70	12	56	71	45	118	HMX3051A107	●
10,80	12	56	71	45	118	HMX3051A108	●
10,90	12	56	71	45	118	HMX3051A109	●
11,00	12	56	71	45	118	HMX3051A110	●
11,10	12	56	71	45	118	HMX3051A111	●
11,20	12	56	71	45	118	HMX3051A112	●
11,30	12	56	71	45	118	HMX3051A113	●
11,40	12	56	71	45	118	HMX3051A114	●
11,50	12	56	71	45	118	HMX3051A115	●
11,60	12	56	71	45	118	HMX3051A116	●
11,70	12	56	71	45	118	HMX3051A117	●
11,80	12	56	71	45	118	HMX3051A118	●
11,90	12	56	71	45	118	HMX3051A119	●
12,00	12	56	71	45	118	HMX3051A120	●
12,10	14	60	77	45	124	HMX3051A121	●
12,20	14	60	77	45	124	HMX3051A122	●
12,30	14	60	77	45	124	HMX3051A123	●
12,40	14	60	77	45	124	HMX3051A124	●
12,50	14	60	77	45	124	HMX3051A125	●
12,60	14	60	77	45	124	HMX3051A126	●
12,70	14	60	77	45	124	HMX3051A127	●
12,80	14	60	77	45	124	HMX3051A128	●
12,90	14	60	77	45	124	HMX3051A129	●

3051A

Punta 5xD con fori
5xD Drill with internal coolant
5xD Bohrer mit IK
5xD Foret avec trous de lubrification



DIN
6537L

DIN
6535 HA
(Standard)



P

K

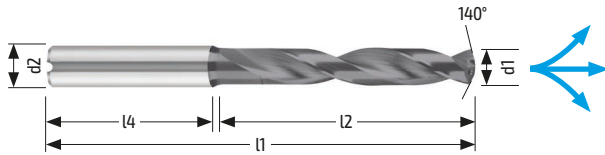

140°

d1 m7	d2 h6	lu	l2	l4	l1	X-Pro Coating	Stock
13,00	14	60	77	45	124	HMX3051A130	●
13,10	14	60	77	45	124	HMX3051A131	●
13,20	14	60	77	45	124	HMX3051A132	●
13,30	14	60	77	45	124	HMX3051A133	○
13,40	14	60	77	45	124	HMX3051A134	○
13,50	14	60	77	45	124	HMX3051A135	●
13,60	14	60	77	45	124	HMX3051A136	○
13,70	14	60	77	45	124	HMX3051A137	○
13,80	14	60	77	45	124	HMX3051A138	●
13,90	14	60	77	45	124	HMX3051A139	○
14,00	14	60	77	45	124	HMX3051A140	●
14,10	16	63	83	48	133	HMX3051A141	○
14,20	16	63	83	48	133	HMX3051A142	●
14,30	16	63	83	48	133	HMX3051A143	○
14,40	16	63	83	48	133	HMX3051A144	○
14,50	16	63	83	48	133	HMX3051A145	●
14,60	16	63	83	48	133	HMX3051A146	○
14,70	16	63	83	48	133	HMX3051A147	○
14,80	16	63	83	48	133	HMX3051A148	●
14,90	16	63	83	48	133	HMX3051A149	○
15,00	16	63	83	48	133	HMX3051A150	●
15,10	16	63	83	48	133	HMX3051A151	○
15,20	16	63	83	48	133	HMX3051A152	●
15,30	16	63	83	48	133	HMX3051A153	○
15,40	16	63	83	48	133	HMX3051A154	○
15,50	16	63	83	48	133	HMX3051A155	●
15,60	16	63	83	48	133	HMX3051A156	○
15,70	16	63	83	48	133	HMX3051A157	○
15,80	16	63	83	48	133	HMX3051A158	●
15,90	16	63	83	48	133	HMX3051A159	○
16,00	16	63	83	48	133	HMX3051A160	●
16,10	18	72	93	48	143	HMX3051A161	○
16,20	18	72	93	48	143	HMX3051A162	○
16,30	18	72	93	48	143	HMX3051A163	○
16,40	18	72	93	48	143	HMX3051A164	○
16,50	18	72	93	48	143	HMX3051A165	●
16,60	18	72	93	48	143	HMX3051A166	○
16,70	18	72	93	48	143	HMX3051A167	○
16,80	18	72	93	48	143	HMX3051A168	○
16,90	18	72	93	48	143	HMX3051A169	○
17,00	18	72	93	48	143	HMX3051A170	●
17,10	18	72	93	48	143	HMX3051A171	○
17,20	18	72	93	48	143	HMX3051A172	○
17,30	18	72	93	48	143	HMX3051A173	○
17,40	18	72	93	48	143	HMX3051A174	○
17,50	18	72	93	48	143	HMX3051A175	●
17,60	18	72	93	48	143	HMX3051A176	○
17,70	18	72	93	48	143	HMX3051A177	○

140°

d1 m7	d2 h6	lu	l2	l4	l1	X-Pro Coating	Stock
17,80	18	72	93	48	143	HMX3051A178	○
17,90	18	72	93	48	143	HMX3051A179	○
18,00	18	72	93	48	143	HMX3051A180	●
18,10	20	79	101	50	153	HMX3051A181	○
18,20	20	79	101	50	153	HMX3051A182	○
18,30	20	79	101	50	153	HMX3051A183	○
18,40	20	79	101	50	153	HMX3051A184	○
18,50	20	79	101	50	153	HMX3051A185	●
18,60	20	79	101	50	153	HMX3051A186	○
18,70	20	79	101	50	153	HMX3051A187	○
18,80	20	79	101	50	153	HMX3051A188	○
18,90	20	79	101	50	153	HMX3051A189	○
19,00	20	79	101	50	153	HMX3051A190	●
19,10	20	79	101	50	153	HMX3051A191	○
19,20	20	79	101	50	153	HMX3051A192	○
19,30	20	79	101	50	153	HMX3051A193	○
19,40	20	79	101	50	153	HMX3051A194	○
19,50	20	79	101	50	153	HMX3051A195	●
19,60	20	79	101	50	153	HMX3051A196	○
19,70	20	79	101	50	153	HMX3051A197	○
19,80	20	79	101	50	153	HMX3051A198	○
19,90	20	79	101	50	153	HMX3051A199	○
20,00	20	79	101	50	153	HMX3051A200	●

Notes _____

3081A

Punta 8xD con fori
8xD Drill with internal coolant
8xD Bohrer mit IK
8xD Foret avec trous de lubrification

Silmax
NORMDIN
6535 HA
(Standard)

P

K



140°

d1 h8	d2 h6	lu	l2	l4	l1	X-Pro Coating	Stock
3,00	6	29	35	36	74	HMX3081A030	●
3,10	6	30	35	36	74	HMX3081A031	○
3,20	6	30	35	36	74	HMX3081A032	●
3,30	6	30	35	36	74	HMX3081A033	●
3,40	6	30	35	36	74	HMX3081A034	●
3,50	6	30	35	36	74	HMX3081A035	●
3,60	6	30	35	36	74	HMX3081A036	○
3,70	6	30	35	36	74	HMX3081A037	○
3,80	6	37	44	36	82	HMX3081A038	○
3,90	6	37	44	36	82	HMX3081A039	○
4,00	6	37	44	36	82	HMX3081A040	●
4,10	6	37	44	36	82	HMX3081A041	○
4,20	6	37	44	36	82	HMX3081A042	●
4,30	6	37	44	36	82	HMX3081A043	●
4,40	6	37	44	36	82	HMX3081A044	○
4,50	6	37	44	36	82	HMX3081A045	●
4,60	6	37	44	36	82	HMX3081A046	○
4,70	6	48	57	36	82	HMX3081A047	○
4,80	6	48	57	36	95	HMX3081A048	●
4,90	6	48	57	36	95	HMX3081A049	○
5,00	6	48	57	36	95	HMX3081A050	●
5,10	6	48	57	36	95	HMX3081A051	●
5,20	6	48	57	36	95	HMX3081A052	○
5,30	6	48	57	36	95	HMX3081A053	○
5,40	6	48	57	36	95	HMX3081A054	○
5,50	6	48	57	36	95	HMX3081A055	●
5,60	6	48	57	36	95	HMX3081A056	○
5,70	6	48	57	36	95	HMX3081A057	○
5,80	6	48	57	36	95	HMX3081A058	●
5,90	6	48	57	36	95	HMX3081A059	○
6,00	6	48	57	36	95	HMX3081A060	●
6,10	8	66	76	36	114	HMX3081A061	●
6,20	8	66	76	36	114	HMX3081A062	○
6,30	8	66	76	36	114	HMX3081A063	●
6,40	8	66	76	36	114	HMX3081A064	○
6,50	8	66	76	36	114	HMX3081A065	●

P

Acciaio
Steel
Stahl
Acier

H

Acciaio Temprato
Hardened Steel
Gehärteter Stahl
Acier trempé

K

Ghisa
Cast Iron
Gusseisen
Fonte

M

Acciaio Inox
Stainless Steel
Edelstahl
Acier Inoxydable

S

HRSA - Titanio
HRSA - Titanium
HRSA - Titan
HRSA - Titane

N

Metalli non ferrosi
Non-ferrous metals
NE-Metalle
Matières non ferreuses

O

NON ISO
Not ISO
Keine ISO
Pas d'ISO

● Disponibilità pronta consegna
Availability for prompt delivery

⌚ Consegna 5 giorni data ordine
Delivery 5 days order date

○ Disponibilità su richiesta
Availability on request

140°

d1 h8	d2 h6	lu	l2	l4	l1	X-Pro Coating	Stock
6,60	8	66	76	36	114	HMX3081A066	●
6,70	8	66	76	36	114	HMX3081A067	○
6,80	8	66	76	36	114	HMX3081A068	●
6,90	8	66	76	36	114	HMX3081A069	●
7,00	8	66	76	36	114	HMX3081A070	●
7,10	8	66	76	36	114	HMX3081A071	○
7,20	8	66	76	36	114	HMX3081A072	○
7,30	8	66	76	36	114	HMX3081A073	○
7,40	8	66	76	36	114	HMX3081A074	○
7,50	8	66	76	36	114	HMX3081A075	●
7,60	8	66	76	36	114	HMX3081A076	○
7,70	8	66	76	36	114	HMX3081A077	○
7,80	8	66	76	36	114	HMX3081A078	●
7,90	8	66	76	36	114	HMX3081A079	○
8,00	8	66	76	36	114	HMX3081A080	●
8,10	10	84	96	40	138	HMX3081A081	○
8,20	10	84	96	40	138	HMX3081A082	○
8,30	10	84	96	40	138	HMX3081A083	○
8,40	10	84	96	40	138	HMX3081A084	○
8,50	10	84	96	40	138	HMX3081A085	●
8,60	10	84	96	40	138	HMX3081A086	○
8,70	10	84	96	40	138	HMX3081A087	●
8,80	10	84	96	40	138	HMX3081A088	○
8,90	10	84	96	40	138	HMX3081A089	○
9,00	10	84	96	40	138	HMX3081A090	●
9,10	10	84	96	40	138	HMX3081A091	○
9,20	10	84	96	40	138	HMX3081A092	○
9,30	10	84	96	40	138	HMX3081A093	●
9,40	10	84	96	40	138	HMX3081A094	○
9,50	10	84	96	40	138	HMX3081A095	●
9,60	10	84	96	40	138	HMX3081A096	○
9,70	10	84	96	40	138	HMX3081A097	○
9,80	10	84	96	40	138	HMX3081A098	●
9,90	10	84	96	40	138	HMX3081A099	○
10,00	10	84	96	40	138	HMX3081A100	●
10,10	12	100	115	45	162	HMX3081A101	○
10,20	12	100	115	45	162	HMX3081A102	○
10,30	12	100	115	45	162	HMX3081A103	●
10,40	12	100	115	45	162	HMX3081A104	○
10,50	12	100	115	45	162	HMX3081A105	●
10,60	12	100	115	45	162	HMX3081A106	○
10,70	12	100	115	45	162	HMX3081A107	○
10,80	12	100	115	45	162	HMX3081A108	○
10,90	12	100	115	45	162	HMX3081A109	○
11,00	12	100	115	45	162	HMX3081A110	●
11,10	12	100	115	45	162	HMX3081A111	○
11,20	12	100	115	45	162	HMX3081A112	○
11,30	12	100	115	45	162	HMX3081A113	○
11,40	12	100	115	45	162	HMX3081A114	●
11,50	12	100	115	45	162	HMX3081A115	●
11,60	12	100	115	45	162	HMX3081A116	○
11,70	12	100	115	45	162	HMX3081A117	○
11,80	12	100	115	45	162	HMX3081A118	○
11,90	12	100	115	45	162	HMX3081A119	●
12,00	12	100	115	45	162	HMX3081A120	●
12,10	14	117	134	45	181	HMX3081A121	○
12,20	14	117	134	45	181	HMX3081A122	○
12,30	14	117	134	45	181	HMX3081A123	○
12,40	14	117	134	45	181	HMX3081A124	○
12,50	14	117	134	45	181	HMX3081A125	●
12,60	14	117	134	45	181	HMX3081A126	○
12,70	14	117	134	45	181	HMX3081A127	○
12,80	14	117	134	45	181	HMX3081A128	○
12,90	14	117	134	45	181	HMX3081A129	○

3081A

Punta 8xD con fori
8xD Drill with internal coolant
8xD Bohrer mit IK
8xD Foret avec trous de lubrification



Silmax
NORM

DIN
6535 HA
(Standard)



P

K

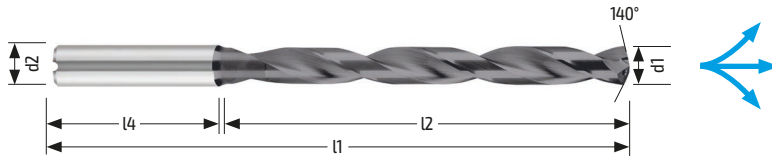

140°

d1 h8	d2 h6	lu	l2	l4	l1	X-Pro Coating	Stock
13,00	14	117	134	45	181	HMX3081A130	●
13,10	14	117	134	45	181	HMX3081A131	○
13,20	14	117	134	45	181	HMX3081A132	○
13,30	14	117	134	45	181	HMX3081A133	○
13,40	14	117	134	45	181	HMX3081A134	○
13,50	14	117	134	45	181	HMX3081A135	●
13,60	14	117	134	45	181	HMX3081A136	○
13,70	14	117	134	45	181	HMX3081A137	○
13,80	14	117	134	45	181	HMX3081A138	○
13,90	14	117	134	45	181	HMX3081A139	○
14,00	14	117	134	45	181	HMX3081A140	●
14,10	16	133	153	48	203	HMX3081A141	○
14,20	16	133	153	48	203	HMX3081A142	○
14,30	16	133	153	48	203	HMX3081A143	○
14,40	16	133	153	48	203	HMX3081A144	○
14,50	16	133	153	48	203	HMX3081A145	●
14,60	16	133	153	48	203	HMX3081A146	○
14,70	16	133	153	48	203	HMX3081A147	○
14,80	16	133	153	48	203	HMX3081A148	○
14,90	16	133	153	48	203	HMX3081A149	○
15,00	16	133	153	48	203	HMX3081A150	●
15,10	16	133	153	48	203	HMX3081A151	○
15,20	16	133	153	48	203	HMX3081A152	○
15,30	16	133	153	48	203	HMX3081A153	○
15,40	16	133	153	48	203	HMX3081A154	○
15,50	16	133	153	48	203	HMX3081A155	○
15,60	16	133	153	48	203	HMX3081A156	○
15,70	16	133	153	48	203	HMX3081A157	○
15,80	16	133	153	48	203	HMX3081A158	○
15,90	16	133	153	48	203	HMX3081A159	○
16,00	16	133	153	48	203	HMX3081A160	●
16,10	18	150	171	48	223	HMX3081A161	○
16,20	18	150	171	48	223	HMX3081A162	○
16,30	18	150	171	48	223	HMX3081A163	○
16,40	18	150	171	48	223	HMX3081A164	○
16,50	18	150	171	48	223	HMX3081A165	○
16,60	18	150	171	48	223	HMX3081A166	○
16,70	18	150	171	48	223	HMX3081A167	○
16,80	18	150	171	48	223	HMX3081A168	○
16,90	18	150	171	48	223	HMX3081A169	○
17,00	18	150	171	48	223	HMX3081A170	●
17,10	18	150	171	48	223	HMX3081A171	○
17,20	18	150	171	48	223	HMX3081A172	○
17,30	18	150	171	48	223	HMX3081A173	○
17,40	18	150	171	48	223	HMX3081A174	○
17,50	18	150	171	48	223	HMX3081A175	○
17,60	18	150	171	48	223	HMX3081A176	○
17,70	18	150	171	48	223	HMX3081A177	○

140°

d1 h8	d2 h6	lu	l2	l4	l1	X-Pro Coating	Stock
17,80	18	150	171	48	223	HMX3081A178	○
17,90	18	150	171	48	223	HMX3081A179	○
18,00	18	150	171	48	223	HMX3081A180	●
18,10	20	168	190	50	244	HMX3081A181	○
18,20	20	168	190	50	244	HMX3081A182	○
18,30	20	168	190	50	244	HMX3081A183	○
18,40	20	168	190	50	244	HMX3081A184	○
18,50	20	168	190	50	244	HMX3081A185	○
18,60	20	168	190	50	244	HMX3081A186	○
18,70	20	168	190	50	244	HMX3081A187	○
18,80	20	168	190	50	244	HMX3081A188	○
18,90	20	168	190	50	244	HMX3081A189	○
19,00	20	168	190	50	244	HMX3081A190	●
19,10	20	168	190	50	244	HMX3081A191	○
19,20	20	168	190	50	244	HMX3081A192	○
19,30	20	168	190	50	244	HMX3081A193	○
19,40	20	168	190	50	244	HMX3081A194	○
19,50	20	168	190	50	244	HMX3081A195	○
19,60	20	168	190	50	244	HMX3081A196	○
19,70	20	168	190	50	244	HMX3081A197	○
19,80	20	168	190	50	244	HMX3081A198	○
19,90	20	168	190	50	244	HMX3081A199	○
20,00	20	168	190	50	244	HMX3081A200	●

Notes _____

3121A

Punta 12xD con fori
12xD Drill with internal coolant
12xD Bohrer mit IK
12xD Foret avec trous de lubrification



Silmax
NORM

DIN
6535 HA
(Standard)



P

K

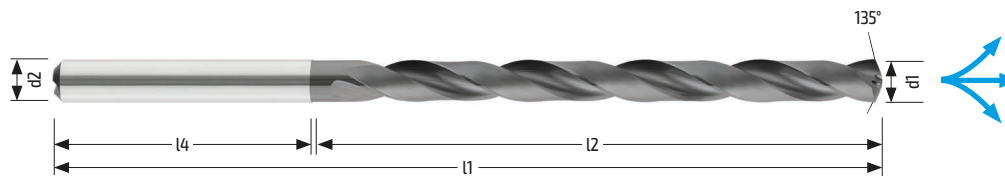

135°

d1 h7	d2 h6	lu	l2	l4	l1	X-Pro Coating	Stock
3,00	6	48	54	36	92	HMX3121A030	●
3,10	6	48	54	36	92	HMX3121A031	●
3,20	6	48	54	36	92	HMX3121A032	●
3,30	6	48	54	36	92	HMX3121A033	●
3,40	6	48	54	36	92	HMX3121A034	●
3,50	6	48	54	36	92	HMX3121A035	●
3,60	6	48	54	36	92	HMX3121A036	●
3,70	6	48	54	36	92	HMX3121A037	●
3,80	6	58	64	36	102	HMX3121A038	●
3,90	6	58	64	36	102	HMX3121A039	●
4,00	6	58	64	36	102	HMX3121A040	●
4,10	6	58	64	36	102	HMX3121A041	●
4,20	6	58	64	36	102	HMX3121A042	●
4,30	6	58	64	36	102	HMX3121A043	●
4,40	6	58	64	36	102	HMX3121A044	●
4,50	6	58	64	36	102	HMX3121A045	●
4,60	6	58	64	36	102	HMX3121A046	●
4,70	6	58	64	36	102	HMX3121A047	●
4,80	6	70	78	36	116	HMX3121A048	●
4,90	6	70	78	36	116	HMX3121A049	●
5,00	6	70	78	36	116	HMX3121A050	●
5,10	6	70	78	36	116	HMX3121A051	●
5,20	6	70	78	36	116	HMX3121A052	●
5,50	6	70	78	36	116	HMX3121A055	●
5,80	6	70	78	36	116	HMX3121A058	●
6,00	6	70	78	36	116	HMX3121A060	●
6,30	8	94	108	36	146	HMX3121A063	●
6,50	8	94	108	36	146	HMX3121A065	●
6,60	8	94	108	36	146	HMX3121A066	●
6,80	8	94	108	36	146	HMX3121A068	●
7,00	8	94	108	36	146	HMX3121A070	●
7,40	8	94	108	36	146	HMX3121A074	●
7,50	8	94	108	36	146	HMX3121A075	●
7,80	8	94	108	36	146	HMX3121A078	●
8,00	8	94	108	36	146	HMX3121A080	●
8,10	10	110	120	40	162	HMX3121A081	●

P

Acciaio
Steel
Stahl
Acier

H

Acciaio Temprato
Hardened Steel
Gehärteter Stahl
Acier trempé

K

Ghisa
Cast Iron
Gusseisen
Fonte

M

Acciaio Inox
Stainless Steel
Edelstahl
Acier Inoxydable

S

HRSA - Titanio
HRSA - Titanium
HRSA - Titan
HRSA - Titane

N

Metalli non ferrosi
Non-ferrous metals
NE-Metalle
Matières non ferreuses

O

NON ISO
Not ISO
Keine ISO
Pas d'ISO

● Disponibilità pronta consegna
Availability for prompt delivery

○ Consegna 5 giorni data ordine
Delivery 5 days order date

○ Disponibilità su richiesta
Availability on request

135°

d1 h7	d2 h6	lu	l2	l4	l1	X-Pro Coating	Stock
8,20	10	110	120	40	162	HMX3121A082	⦿
8,50	10	110	120	40	162	HMX3121A085	●
9,00	10	110	120	40	162	HMX3121A090	●
9,30	10	110	120	40	162	HMX3121A093	⦿
9,50	10	110	120	40	162	HMX3121A095	●
9,80	10	110	120	40	162	HMX3121A098	●
10,00	10	110	120	40	162	HMX3121A100	●
10,20	12	142	156	45	204	HMX3121A102	●
10,50	12	142	156	45	204	HMX3121A105	●
11,00	12	142	156	45	204	HMX3121A110	●
11,50	12	142	156	45	204	HMX3121A115	●
11,80	12	142	156	45	204	HMX3121A118	●
12,00	12	142	156	45	204	HMX3121A120	●
12,50	14	166	182	45	230	HMX3121A125	●
13,00	14	166	182	45	230	HMX3121A130	●
13,50	14	166	182	45	230	HMX3121A135	⦿
14,00	14	166	182	45	230	HMX3121A140	●
15,00	16	192	208	48	260	HMX3121A150	⦿
16,00	16	192	208	48	260	HMX3121A160	⦿
17,00	18	216	234	48	285	HMX3121A170	⦿
17,50	18	216	234	48	285	HMX3121A175	⦿
18,00	18	216	234	48	285	HMX3121A180	⦿

Notes _____

PUNTE HM PER ACCIAIO 4 PATTINI FINO 12xD

4 DOUBLE MARGIN HM DRILLS FOR STEEL UP TO 12xD / HM-BOHRER FÜR STAHL MIT 4 FUEHRUNGSFASEN BIS 12xD / FORETS HM POUR ACIER 4 PATINS DE GUIDAGE JUSQU'À 12xD

3054A

Punta 4 pattini 5xD con fori
5xD Drill with internal coolant
5xD Bohrer mit IK
5xD Foret avec trous de lubrification



DIN
6537L

DIN
6535 HA
(Standard)



P

K

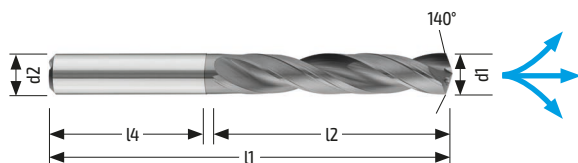

140°

d1 k7	d2 h6	lu	l2	l4	l1	Balinit® Latuma Coating	Stock
3,00	6	23	28	36	66	HMC3054A030	●
3,10	6	23	28	36	66	HMC3054A031	●
3,20	6	23	28	36	66	HMC3054A032	●
3,30	6	23	28	36	66	HMC3054A033	●
3,40	6	23	28	36	66	HMC3054A034	●
3,50	6	23	28	36	66	HMC3054A035	●
3,70	6	23	28	36	66	HMC3054A037	●
3,80	6	29	36	36	74	HMC3054A038	●
3,90	6	29	36	36	74	HMC3054A039	●
4,00	6	29	36	36	74	HMC3054A040	●
4,20	6	29	36	36	74	HMC3054A042	●
4,30	6	29	36	36	74	HMC3054A043	●
4,50	6	29	36	36	74	HMC3054A045	●
4,80	6	35	44	36	82	HMC3054A048	●
5,00	6	35	44	36	82	HMC3054A050	●
5,10	6	35	44	36	82	HMC3054A051	●
5,20	6	35	44	36	82	HMC3054A052	●
5,30	6	35	44	36	82	HMC3054A053	●
5,50	6	35	44	36	82	HMC3054A055	●
5,60	6	35	44	36	82	HMC3054A056	●
5,80	6	35	44	36	82	HMC3054A058	●
5,90	6	35	44	36	82	HMC3054A059	●
6,00	6	35	44	36	82	HMC3054A060	●
6,40	8	43	53	36	91	HMC3054A064	●
6,50	8	43	53	36	91	HMC3054A065	●
6,60	8	43	53	36	91	HMC3054A066	●

P

Acciaio
Steel
Stahl
Acier

H

Acciaio Temprato
Hardened Steel
Gehärteter Stahl
Acier trempé

K

Ghisa
Cast Iron
Gusseisen
Fonte

M

Acciaio Inox
Stainless Steel
Edelstahl
Acier Inoxydable

S

HRSA - Titanio
HRSA - Titanium
HRSA - Titan
HRSA - Titane

N

Metalli non ferrosi
Non-ferrous metals
NE-Metalle
Matières non ferreuses

O

NON ISO
Not ISO
Keine ISO
Pas d'ISO

● Disponibilità pronta consegna
Availability for prompt delivery

◐ Consegna 5 giorni data ordine
Delivery 5 days order date

○ Disponibilità su richiesta
Availability on request

140°

d1 k7	d2 h6	lu	l2	l4	l1	Balinit® Latuma Coating	Stock
6,70	8	43	53	36	91	HMC3054A067	●
6,80	8	43	53	36	91	HMC3054A068	●
6,90	8	43	53	36	91	HMC3054A069	●
7,00	8	43	53	36	91	HMC3054A070	●
7,20	8	43	53	36	91	HMC3054A072	●
7,40	8	43	53	36	91	HMC3054A074	●
7,50	8	43	53	36	91	HMC3054A075	●
7,80	8	43	53	36	91	HMC3054A078	●
7,90	8	43	53	36	91	HMC3054A079	●
8,00	8	43	53	36	91	HMC3054A080	●
8,10	10	49	61	40	103	HMC3054A081	●
8,30	10	49	61	40	103	HMC3054A083	●
8,40	10	49	61	40	103	HMC3054A084	●
8,50	10	49	61	40	103	HMC3054A085	●
8,60	10	49	61	40	103	HMC3054A086	●
8,80	10	49	61	40	103	HMC3054A088	●
9,00	10	49	61	40	103	HMC3054A090	●
9,20	10	49	61	40	103	HMC3054A092	●
9,30	10	49	61	40	103	HMC3054A093	●
9,50	10	49	61	40	103	HMC3054A095	●
9,80	10	49	61	40	103	HMC3054A098	●
9,90	10	49	61	40	103	HMC3054A099	●
10,00	10	49	61	40	103	HMC3054A100	●
10,20	12	56	71	45	118	HMC3054A102	●
10,30	12	56	71	45	118	HMC3054A103	●
10,40	12	56	71	45	118	HMC3054A104	●
10,50	12	56	71	45	118	HMC3054A105	●
10,90	12	56	71	45	118	HMC3054A109	●
11,00	12	56	71	45	118	HMC3054A110	●
11,50	12	56	71	45	118	HMC3054A115	●
11,70	12	56	71	45	118	HMC3054A117	●
11,80	12	56	71	45	118	HMC3054A118	●
12,00	12	56	71	45	118	HMC3054A120	●
12,50	14	60	77	45	124	HMC3054A125	●
13,00	14	60	77	45	124	HMC3054A130	●
13,50	14	60	77	45	124	HMC3054A135	●
14,00	14	60	77	45	124	HMC3054A140	●
14,50	16	63	83	48	133	HMC3054A145	●
14,80	16	63	83	48	133	HMC3054A148	●
15,00	16	63	83	48	133	HMC3054A150	●
15,50	16	63	83	48	133	HMC3054A155	●
15,80	16	63	83	48	133	HMC3054A158	●
16,00	16	63	83	48	133	HMC3054A160	●
17,00	18	71	93	48	143	HMC3054A170	●
17,50	18	71	93	48	143	HMC3054A175	●
18,00	18	71	93	48	143	HMC3054A180	●
18,50	20	77	101	50	153	HMC3054A185	●
20,00	20	77	101	50	153	HMC3054A200	●

3084A

Punta 4 pattini 8xD con fori
8xD Drill with internal coolant
8xD Bohrer mit IK
8xD Foret avec trous de lubrification



Silmax
NORM

DIN
6535 HA
(Standard)



P

K

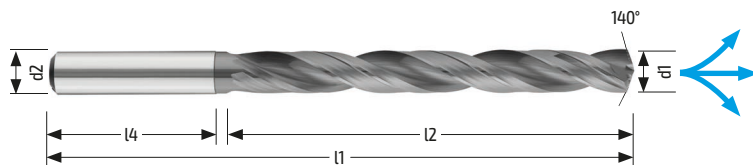

140°

d1 k7	d2 h6	lu	l2	l4	l1	Balinit® Latuma Coating	Stock
3,00	6	29	34	36	72	HMC3084A030	●
3,10	6	29	34	36	72	HMC3084A031	●
3,20	6	29	34	36	72	HMC3084A032	●
3,30	6	29	34	36	72	HMC3084A033	●
3,40	6	29	34	36	72	HMC3084A034	●
3,50	6	29	34	36	72	HMC3084A035	●
3,60	6	29	34	36	72	HMC3084A036	●
3,70	6	29	34	36	72	HMC3084A037	●
3,80	6	36	43	36	81	HMC3084A038	●
3,90	6	36	43	36	81	HMC3084A039	●
4,00	6	36	43	36	81	HMC3084A040	●
4,10	6	36	43	36	81	HMC3084A041	●
4,20	6	36	43	36	81	HMC3084A042	●
4,30	6	36	43	36	81	HMC3084A043	●
4,40	6	36	43	36	81	HMC3084A044	●
4,50	6	36	43	36	81	HMC3084A045	●
4,60	6	36	43	36	81	HMC3084A046	●
4,80	6	48	57	36	95	HMC3084A048	●
4,90	6	48	57	36	95	HMC3084A049	●
5,00	6	48	57	36	95	HMC3084A050	●
5,10	6	48	57	36	95	HMC3084A051	●
5,20	6	48	57	36	95	HMC3084A052	●
5,40	6	48	57	36	95	HMC3084A054	●
5,50	6	48	57	36	95	HMC3084A055	●
5,60	6	48	57	36	95	HMC3084A056	●
5,70	6	48	57	36	95	HMC3084A057	●
5,80	6	48	57	36	95	HMC3084A058	●
6,00	6	48	57	36	95	HMC3084A060	●
6,10	8	64	76	36	114	HMC3084A061	●
6,20	8	64	76	36	114	HMC3084A062	●
6,50	8	64	76	36	114	HMC3084A065	●
6,60	8	64	76	36	114	HMC3084A066	●
6,80	8	64	76	36	114	HMC3084A068	●
6,90	8	64	76	36	114	HMC3084A069	●
7,00	8	64	76	36	114	HMC3084A070	●
7,20	8	64	76	36	114	HMC3084A072	●

P

Acciaio
Steel
Stahl
Acier

H

Acciaio Temprato
Hardened Steel
Gehärteter Stahl
Acier trempé

K

Ghisa
Cast Iron
Gusseisen
Fonte

M

Acciaio Inox
Stainless Steel
Edelstahl
Acier Inoxydable

S

HRSA - Titanio
HRSA - Titanium
HRSA - Titan
HRSA - Titane

N

Metalli non ferrosi
Non-ferrous metals
NE-Metalle
Matières non ferreuses

O

NON ISO
Not ISO
Keine ISO
Pas d'ISO

● Disponibilità pronta consegna
Availability for prompt delivery

○ Consegna 5 giorni data ordine
Delivery 5 days order date

○ Disponibilità su richiesta
Availability on request

140°

d1 k7	d2 h6	lu	l2	l4	l1	Balinit® Latuma Coating	Stock
7,40	8	64	76	36	114	HMC3084A074	●
7,50	8	64	76	36	114	HMC3084A075	●
7,60	8	64	76	36	114	HMC3084A076	●
7,80	8	64	76	36	114	HMC3084A078	●
8,00	8	64	76	36	114	HMC3084A080	●
8,20	10	80	95	40	142	HMC3084A082	●
8,50	10	80	95	40	142	HMC3084A085	●
8,60	10	80	95	40	142	HMC3084A086	●
8,70	10	80	95	40	142	HMC3084A087	●
8,90	10	80	95	40	142	HMC3084A089	●
9,00	10	80	95	40	142	HMC3084A090	●
9,50	10	80	95	40	142	HMC3084A095	●
9,60	10	80	95	40	142	HMC3084A096	●
9,70	10	80	95	40	142	HMC3084A097	●
9,80	10	80	95	40	142	HMC3084A098	●
9,90	10	80	95	40	142	HMC3084A099	●
10,00	10	80	95	40	142	HMC3084A100	●
10,10	12	96	114	45	162	HMC3084A101	●
10,20	12	96	114	45	162	HMC3084A102	●
10,50	12	96	114	45	162	HMC3084A105	●
10,60	12	96	114	45	162	HMC3084A106	●
10,70	12	96	114	45	162	HMC3084A107	●
11,00	12	96	114	45	162	HMC3084A110	●
11,30	12	96	114	45	162	HMC3084A113	●
11,70	12	96	114	45	162	HMC3084A117	●
11,80	12	96	114	45	162	HMC3084A118	●
12,00	12	96	114	45	162	HMC3084A120	●
12,50	14	112	133	45	178	HMC3084A125	●
12,80	14	112	133	45	178	HMC3084A128	●
13,00	14	112	133	45	178	HMC3084A130	●
13,50	14	112	133	45	178	HMC3084A135	●
14,00	14	112	133	45	178	HMC3084A140	●
15,00	16	128	152	48	203	HMC3084A150	●
15,80	16	128	152	48	203	HMC3084A158	●
16,00	16	128	152	48	203	HMC3084A160	●
16,50	18	144	171	48	222	HMC3084A165	●
20,00	20	160	190	50	243	HMC3084A200	●

Notes

3124A

Punta 4 pattini 12xD con fori
12xD Drill with internal coolant
12xD Bohrer mit IK
12xD Foret avec trous de lubrification



Silmax
NORM

DIN
6535 HA
(Standard)



P

K



140°

d1 k7	d2 h6	lu	l2	l4	l1	Balinit® Latuma Coating	Stock
3,00	6	48	54	36	92	HMC3124A030	●
3,10	6	48	54	36	92	HMC3124A031	●
3,20	6	48	54	36	92	HMC3124A032	●
3,30	6	48	54	36	92	HMC3124A033	●
3,40	6	48	54	36	92	HMC3124A034	●
3,50	6	48	54	36	92	HMC3124A035	●
3,60	6	48	54	36	92	HMC3124A036	●
3,70	6	48	54	36	92	HMC3124A037	●
3,80	6	58	64	36	102	HMC3124A038	●
3,90	6	58	64	36	102	HMC3124A039	●
4,00	6	58	64	36	102	HMC3124A040	●
4,10	6	58	64	36	102	HMC3124A041	●
4,20	6	58	64	36	102	HMC3124A042	●
4,30	6	58	64	36	102	HMC3124A043	●
4,40	6	58	64	36	102	HMC3124A044	●
4,50	6	58	64	36	102	HMC3124A045	●
4,60	6	58	64	36	102	HMC3124A046	●
4,70	6	58	64	36	102	HMC3124A047	●
4,80	6	70	78	36	116	HMC3124A048	●
4,05	6	58	64	36	102	HMC3124A04A	●
4,65	6	58	78	36	116	HMC3124A04B	●
5,00	6	70	78	36	116	HMC3124A050	●
5,10	6	70	78	36	116	HMC3124A051	●
5,20	6	70	78	36	116	HMC3124A052	●
5,40	6	70	78	36	116	HMC3124A054	●
5,50	6	70	78	36	116	HMC3124A055	●
5,60	6	70	78	36	116	HMC3124A056	●
5,70	6	70	78	36	116	HMC3124A057	●
5,80	6	70	78	36	116	HMC3124A058	●
5,05	6	70	78	36	116	HMC3124A05A	●
6,00	6	70	78	36	116	HMC3124A060	●
6,10	8	94	108	36	146	HMC3124A061	●
6,40	8	94	108	36	146	HMC3124A064	●
6,50	8	94	108	36	146	HMC3124A065	●
6,80	8	94	108	36	146	HMC3124A068	●
6,90	8	94	108	36	146	HMC3124A069	●

P

Acciaio
Steel
Stahl
Acier

H

Acciaio Temprato
Hardened Steel
Gehärteter Stahl
Acier trempé

K

Ghisa
Cast Iron
Gusseisen
Fonte

M

Acciaio Inox
Stainless Steel
Edelstahl
Acier Inoxydable

S

HRSA - Titanio
HRSA - Titanium
HRSA - Titan
HRSA - Titane

N

Metalli non ferrosi
Non-ferrous metals
NE-Metalle
Matières non ferreuses

O

NON ISO
Not ISO
Keine ISO
Pas d'ISO

● Disponibilità pronta consegna
Availability for prompt delivery

● Consegna 5 giorni data ordine
Delivery 5 days order date

○ Disponibilità su richiesta
Availability on request

140°

d1 k7	d2 h6	lu	l2	l4	l1	Balinit® Latuma Coating	Stock
7,00	8	94	108	36	146	HMC3124A070	●
7,10	8	94	108	36	146	HMC3124A071	●
7,50	8	94	108	36	146	HMC3124A075	●
7,60	8	94	108	36	146	HMC3124A076	●
7,70	8	94	108	36	146	HMC3124A077	●
7,80	8	94	108	36	146	HMC3124A078	●
7,90	8	94	108	36	146	HMC3124A079	●
8,00	8	94	108	36	146	HMC3124A080	●
8,20	10	110	120	40	162	HMC3124A082	●
8,30	10	110	120	40	162	HMC3124A083	●
8,40	10	110	120	40	162	HMC3124A084	●
8,50	10	110	120	40	162	HMC3124A085	●
8,60	10	110	120	40	162	HMC3124A086	●
8,70	10	110	120	40	162	HMC3124A087	●
9,00	10	110	120	40	162	HMC3124A090	●
9,50	10	110	120	40	162	HMC3124A095	●
9,60	10	110	120	40	162	HMC3124A096	●
9,80	10	110	120	40	162	HMC3124A098	●
9,90	10	110	120	40	162	HMC3124A099	●
10,00	10	110	120	40	162	HMC3124A100	●
10,20	12	142	156	45	204	HMC3124A102	●
10,50	12	142	156	45	204	HMC3124A105	●
10,60	12	142	156	45	204	HMC3124A106	●
11,00	12	142	156	45	204	HMC3124A110	●
11,20	12	142	156	45	204	HMC3124A112	●
11,70	12	142	156	45	204	HMC3124A117	●
11,80	12	142	156	45	204	HMC3124A118	●
12,00	12	142	156	45	204	HMC3124A120	●
12,50	14	166	182	45	230	HMC3124A125	●
13,00	14	166	182	45	230	HMC3124A130	●
13,50	14	166	182	45	230	HMC3124A135	●
14,00	14	166	182	45	230	HMC3124A140	●
14,50	16	192	208	48	260	HMC3124A145	●
15,00	16	192	208	48	260	HMC3124A150	●
16,00	16	192	208	48	260	HMC3124A160	●
16,50	18	216	234	48	285	HMC3124A165	●
17,50	18	216	234	48	285	HMC3124A175	●
19,50	20	240	258	50	310	HMC3124A195	●

Notes

PUNTE HM PER ACCIAIO FORATURA PROFONDA FINO 30xD

HM DEEP DRILLINGS FOR STEEL UP TO 30xD /
M-BOHRER ZUM TIEFBOHREN VON STAHL BIS 30xD /
FORETS HM POUR ACIER, POUR DES PROFONDEURS JUSQU'À 30xD

3151A

Punta 15xD con fori
15xD Drill with internal coolant
15xD Bohrer mit IK
15xD Foret avec trous de lubrification



Silmax
NORM

DIN
6535 HA
(Standard)



P

K

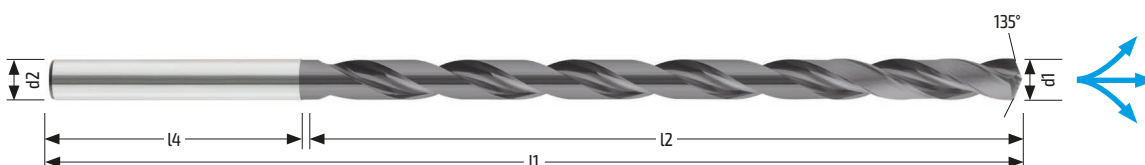

135°

d1 h7	d2 h6	lu	l2	l4	l1	Balinit® Latuma Coating	Stock
3,00	4	52	56	32	90	HMC3151A030	●
3,50	4	61	66	32	100	HMC3151A035	●
4,00	4	60	66	32	100	HMC3151A040	●
4,50	5	67	74	34	110	HMC3151A045	●
5,00	5	77	84	34	120	HMC3151A050	●
5,50	6	84	92	36	130	HMC3151A055	●
6,00	6	93	102	36	140	HMC3151A060	●
7,00	7	105	115	38	155	HMC3151A070	●
8,00	8	121	133	40	175	HMC3151A080	●
9,00	9	135	148	40	190	HMC3151A090	●
9,50	10	153	168	40	210	HMC3151A095	●
10,00	10	153	168	40	210	HMC3151A100	●
11,00	11	167	183	45	230	HMC3151A110	●
12,00	12	185	203	45	250	HMC3151A120	●
13,00	13	199	218	45	265	HMC3151A130	●
14,00	14	212	233	50	285	HMC3151A140	●
15,00	15	231	253	50	305	HMC3151A150	●

P

Acciaio
Steel
Stahl
Acier

H

Acciaio Temprato
Hardened Steel
Gehärteter Stahl
Acier trempé

K

Ghisa
Cast Iron
Gusseisen
Fonte

M

Acciaio Inox
Stainless Steel
Edelstahl
Acier Inoxydable

S

HRSA - Titanio
HRSA - Titanium
HRSA - Titan
HRSA - Titane

N

Metalli non ferrosi
Non-ferrous metals
NE-Metalle
Matières non ferreuses

O

NON ISO
Not ISO
Keine ISO
Pas d'ISO

● Disponibilità pronta consegna
Availability for prompt delivery

● Consegna 5 giorni data ordine
Delivery 5 days order date

○ Disponibilità su richiesta
Availability on request

3201A

Punta 20xD con fori
 20xD Drill with internal coolant
 20xD Bohrer mit IK
 20xD Foret avec trous de lubrification



Silmax
NORM

DIN
6535 HA
(Standard)



P

K

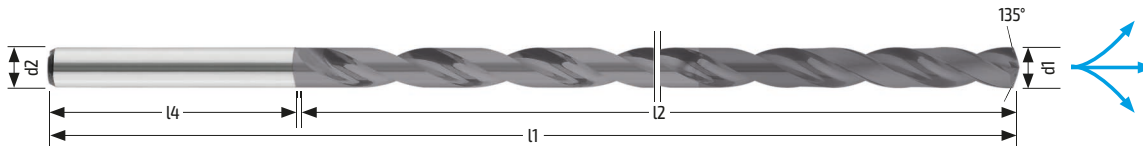

135°	d1 h7	d2 h6	l4	l2	l4	l1	Balinit® Latuma Coating	Stock
	3,00	4	70	74	32	110	HMC3201A030	●
	3,50	4	81	86	32	120	HMC3201A035	●
	4,00	4	80	86	32	120	HMC3201A040	●
	5,00	5	102	109	34	145	HMC3201A050	●
	5,50	6	112	120	36	160	HMC3201A055	●
	6,00	6	121	130	36	170	HMC3201A060	●
	6,50	7	140	150	36	190	HMC3201A065	●
	7,00	7	140	150	38	190	HMC3201A070	●
	8,00	8	161	173	40	215	HMC3201A080	●
	9,00	9	183	196	40	240	HMC3201A090	●
	10,00	10	203	218	40	260	HMC3201A100	●
	11,00	11	222	238	45	285	HMC3201A110	●
	12,00	12	240	258	45	305	HMC3201A120	●
	14,00	14	282	303	50	355	HMC3201A140	●
	15,00	15	301	323	50	375	HMC3201A150	●
	16,00	16	324	348	50	400	HMC3201A160	●

P
 Acciaio
 Steel
 Stahl
 Acier

H
 Acciaio Temprato
 Hardened Steel
 Gehärteter Stahl
 Acier trempé

K
 Ghisa
 Cast Iron
 Gusseisen
 Fonte

M
 Acciaio Inox
 Stainless Steel
 Edelstahl
 Acier Inoxydable

S
 HRSA - Titanio
 HRSA - Titanium
 HRSA - Titan
 HRSA - Titane

N
 Metalli non ferrosi
 Non-ferrous metals
 NE-Metalle
 Matières non ferreuses

O
 NON ISO
 Not ISO
 Keine ISO
 Pas d'ISO

● **Disponibilità pronta consegna**
 Availability for prompt delivery

⦿ **Consegna 5 giorni data ordine**
 Delivery 5 days order date

○ **Disponibilità su richiesta**
 Availability on request

3251A

Punta 25xD con fori
25xD Drill with internal coolant
25xD Bohrer mit IK
25xD Foret avec trous de lubrification



Silmax
NORM

DIN
6535 HA
(Standard)



P

K

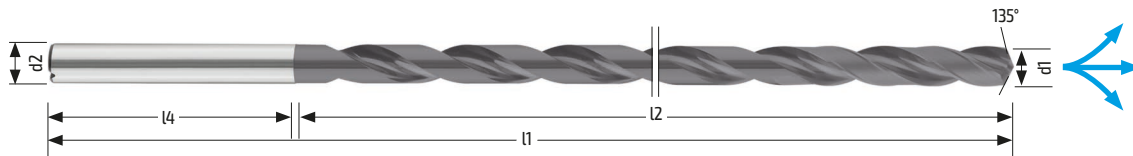

135°

d1 h7	d2 h6	l4	l2	l4	l1	Balinit® Latuma Coating	Stock
3,00	4	87	91	32	125	HMC3251A030	●
3,50	4	101	106	32	140	HMC3251A035	●
4,00	4	100	106	32	140	HMC3251A040	●
5,00	5	127	134	34	170	HMC3251A050	●
5,50	6	139	147	36	185	HMC3251A055	●
6,00	6	151	160	36	200	HMC3251A060	●
7,00	7	175	185	38	225	HMC3251A070	●
8,00	8	201	213	40	255	HMC3251A080	●
9,00	9	225	238	40	280	HMC3251A090	●
10,00	10	253	268	40	310	HMC3251A100	●
11,00	11	277	293	45	340	HMC3251A110	●
12,00	12	300	318	45	365	HMC3251A120	●
14,00	14	352	373	50	425	HMC3251A140	●

P

Acciaio
Steel
Stahl
Acier

H

Acciaio Temprato
Hardened Steel
Gehärteter Stahl
Acier trempé

K

Ghisa
Cast Iron
Gusseisen
Fonte

M

Acciaio Inox
Stainless Steel
Edelstahl
Acier Inoxydable

S

HRSA - Titanio
HRSA - Titanium
HRSA - Titan
HRSA - Titane

N

Metalli non ferrosi
Non-ferrous metals
NE-Metalle
Matières non ferreuses

O

NON ISO
Not ISO
Keine ISO
Pas d'ISO

● Disponibilità pronta consegna
Availability for prompt delivery

◐ Consegna 5 giorni data ordine
Delivery 5 days order date

○ Disponibilità su richiesta
Availability on request

3301A

Punta 30xD con fori
30xD Drill with internal coolant
30xD Bohrer mit IK
30xD Foret avec trous de lubrification



Silmax
NORM

DIN
6535 HA
(Standard)



P

K

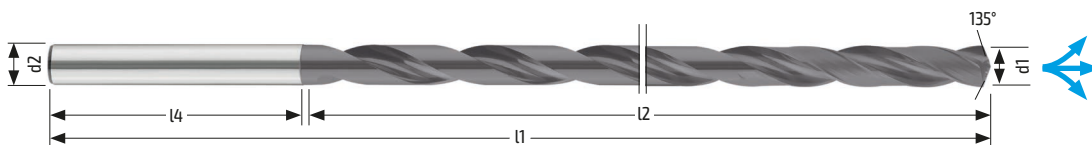

135°	d1 h7	d2 h6	l4	l2	l4	l1	Balinit® Latuma Coating	Stock
	3,00	4	106	110	32	145	HMC3301A030	●
	4,00	4	120	126	32	160	HMC3301A040	●
	4,50	5	137	144	34	180	HMC3301A045	●
	5,00	5	152	159	34	195	HMC3301A050	●
	5,50	6	164	172	36	210	HMC3301A055	●
	6,00	6	183	192	36	230	HMC3301A060	●
	7,00	7	210	220	38	260	HMC3301A070	●
	8,00	8	241	253	40	295	HMC3301A080	●
	9,00	9	270	283	40	325	HMC3301A090	●
	10,00	10	303	318	40	360	HMC3301A100	●
	11,00	11	337	353	45	400	HMC3301A110	●
	12,00	12	365	383	45	430	HMC3301A120	●

- P**

Acciaio
Steel
Stahl
Acier
- H**

Acciaio Temprato
Hardened Steel
Gehärteter Stahl
Acier trempé
- K**

Ghisa
Cast Iron
Gusseisen
Fonte
- M**

Acciaio Inox
Stainless Steel
Edelstahl
Acier Inoxydable
- S**

HRSA - Titanio
HRSA - Titanium
HRSA - Titan
HRSA - Titane
- N**

Metalli non ferrosi
Non-ferrous metals
NE-Metalle
Matières non ferreuses
- O**

NON ISO
Not ISO
Keine ISO
Pas d'ISO

- **Disponibilità pronta consegna**
Availability for prompt delivery
- ⌚ **Consegna 5 giorni data ordine**
Delivery 5 days order date
- **Disponibilità su richiesta**
Availability on request

PUNTE HM FORA ALESA

HM DRILLINGS-BORING / HM BOHREIBAHLE /
FORETS HM PERÇAGE-ALÉSAGE

4031A

Punta fora-alesa 3xD con fori
3xD Drilling-Boring with internal coolant
3xD Bohrreibahle mit IK
Foret perçage-alésage 3xD avec trous de lubrification

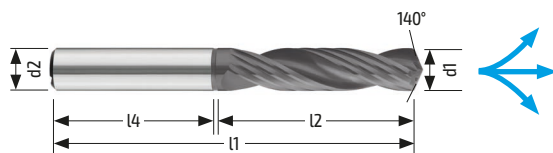
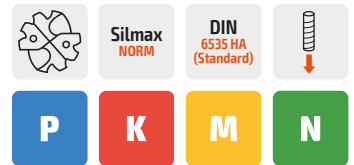

140°	d1 +/- 0,003	 *min-max	d2 h6	lu	l2	l4	l1	Balinit® Latuma Coating	Stock
	4,00 H7	4,000 - 4,012	6	17	24	36	66	HMC4031A040H	●
	5,00 H7	5,000 - 5,012	6	24	34	36	79	HMC4031A050H	●
	6,00	5,995 - 6,010	6	24	34	36	79	HMC4031A0600	●
	6,00 H7	6,000 - 6,012	6	24	34	36	79	HMC4031A060H	●
	6,01	6,005 - 6,020	6	24	34	36	79	HMC4031A0601	●
	6,02	6,015 - 6,030	6	24	34	36	79	HMC4031A0602	●
	7,00 H7	7,000 - 7,012	8	24	34	36	79	HMC4031A070H	●
	8,00	7,995 - 8,010	8	24	34	36	79	HMC4031A0800	●
	8,00 H7	8,000 - 8,012	8	24	34	36	79	HMC4031A080H	●
	8,01	8,005 - 8,020	8	24	34	36	79	HMC4031A0801	●
	8,02	8,015 - 8,030	8	24	34	36	79	HMC4031A0802	●
	10,00	9,995 - 10,010	10	35	47	40	89	HMC4031A1000	●
	10,00 H7	10,000 - 10,012	10	35	47	40	89	HMC4031A100H	●
	10,01	10,005 - 10,020	10	35	47	40	89	HMC4031A1001	●
	10,02	10,015 - 10,030	10	35	47	40	89	HMC4031A1002	●
	12,00	11,994 - 12,012	12	40	55	45	102	HMC4031A1200	●
	12,00 H7	12,000 - 12,012	12	40	55	45	102	HMC4031A120H	●
	14,00 H7	14,000 - 14,012	14	43	60	45	107	HMC4031A140H	●
	16,00 H7	16,000 - 16,012	16	45	65	48	115	HMC4031A160H	●

P

Acciaio
Steel
Stahl
Acier

H

Acciaio Temprato
Hardened Steel
Gehärteter Stahl
Acier trempé

K

Ghisa
Cast Iron
Gusseisen
Fonte

M

Acciaio Inox
Stainless Steel
Edelstahl
Acier Inoxydable

S

HRSA - Titanio
HRSA - Titanium
HRSA - Titan
HRSA - Titane

N

Metalli non ferrosi
Non-ferrous metals
NE-Metalle
Matières non ferreuses

O

NON ISO
Not ISO
Keine ISO
Pas d'ISO

● **Disponibilità pronta consegna**
Availability for prompt delivery

● **Consegna 5 giorni data ordine**
Delivery 5 days order date

○ **Disponibilità su richiesta**
Availability on request

4051A

Punta fora-alesa 5xD con fori
5xD Drilling-Boring with internal coolant
5xD Bohrreibahle mit IK
Foret perçage-alésage 5xD avec trous de lubrification



Silmax
NORM

DIN
6535 HA
(Standard)

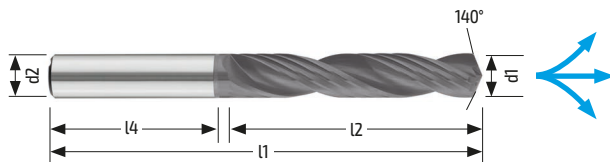

140°	d1 +/- 0,003	\varnothing *min-max	d2 h6	lu	l2	l4	l1	Balinit® Latuma Coating	Stock
	4,00 H7	4,000 - 4,012	6	29	36	36	74	HMC4051A040H	●
	5,00 H7	5,000 - 5,012	6	43	53	36	91	HMC4051A050H	●
	6,00	5,995 - 6,010	6	43	53	36	91	HMC4051A0600	●
	6,00 H7	6,000 - 6,012	6	43	53	36	91	HMC4051A060H	●
	6,01	6,005 - 6,020	6	43	53	36	91	HMC4051A0601	●
	6,02	6,015 - 6,030	6	43	53	36	91	HMC4051A0602	●
	7,00 H7	7,000 - 7,012	8	43	53	36	91	HMC4051A070H	⊙
	8,00	7,995 - 8,010	8	43	53	36	91	HMC4051A0800	●
	8,00 H7	8,000 - 8,012	8	43	53	36	91	HMC4051A080H	●
	8,01	8,005 - 8,020	8	43	53	36	91	HMC4051A0801	●
	8,02	8,015 - 8,030	8	43	53	36	91	HMC4051A0802	●
	10,00 H7	10,000 - 10,012	10	49	61	40	103	HMC4051A100H	●
	10,01	10,005 - 10,020	10	49	61	40	103	HMC4051A1001	●
	10,02	10,015 - 10,030	10	49	61	40	103	HMC4051A1002	●
	12,00	11,994 - 12,012	12	56	71	45	118	HMC4051A1200	●
	12,00 H7	12,000 - 12,012	12	56	71	45	118	HMC4051A120H	●
	12,01	12,004 - 12,022	12	56	71	45	118	HMC4051A1201	●
	12,02	12,014 - 12,032	12	56	71	45	118	HMC4051A1202	●
	14,00 H7	14,000 - 14,012	14	60	77	45	124	HMC4051A140H	●
	16,00 H7	16,000 - 16,012	16	63	83	48	133	HMC4051A160H	●

P

Acciaio
Steel
Stahl
Acier

H

Acciaio Temprato
Hardened Steel
Gehärteter Stahl
Acier trempé

K

Ghisa
Cast Iron
Gusseisen
Fonte

M

Acciaio Inox
Stainless Steel
Edelstahl
Acier Inoxydable

S

HRSA - Titanio
HRSA - Titanium
HRSA - Titan
HRSA - Titane

N

Metalli non ferrosi
Non-ferrous metals
NE-Metalle
Matières non ferreuses

O

NON ISO
Not ISO
Keine ISO
Pas d'ISO

● Disponibilità pronta consegna
Availability for prompt delivery

⊙ Consegna 5 giorni data ordine
Delivery 5 days order date

○ Disponibilità su richiesta
Availability on request

PUNTE HM PIATTE

HM FLAT DRILLS / HM-FLACHBOHRER

FORETS HM MONOBLOC TYPE PLAT

4038A

Punta piatta 3xD con fori
Flat Drill 3xD with holes
Flachbohrer 3xD mit Kanal
Foret plat 3xD avec trous



Silmax
NORM

DIN
6535 HA
(Standard)



P

K

M

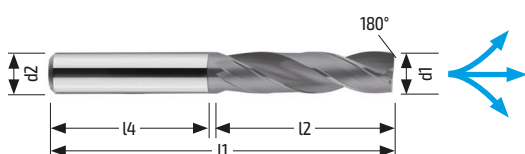

180°

d1 m7	d2 h6	lu	l2	l4	l1	Balinit® Latuma Coating	Stock
3,00	6	14	20	36	62	HMC4038A030	●
3,10	6	14	20	36	62	HMC4038A031	●
3,20	6	14	20	36	62	HMC4038A032	●
3,30	6	14	20	36	62	HMC4038A033	●
3,40	6	14	20	36	62	HMC4038A034	●
3,50	6	14	20	36	62	HMC4038A035	●
3,60	6	14	20	36	62	HMC4038A036	●
3,70	6	14	20	36	62	HMC4038A037	●
3,80	6	17	24	36	66	HMC4038A038	●
3,90	6	17	24	36	66	HMC4038A039	●
4,00	6	17	24	36	66	HMC4038A040	●
4,10	6	17	24	36	66	HMC4038A041	●
4,20	6	17	24	36	66	HMC4038A042	●
4,30	6	17	24	36	66	HMC4038A043	●
4,40	6	17	24	36	66	HMC4038A044	●
4,50	6	17	24	36	66	HMC4038A045	●
4,60	6	17	24	36	66	HMC4038A046	●
4,70	6	17	24	36	66	HMC4038A047	●
4,80	6	20	28	36	66	HMC4038A048	●
4,90	6	20	28	36	66	HMC4038A049	●
5,00	6	20	28	36	66	HMC4038A050	●
5,10	6	20	28	36	66	HMC4038A051	●
5,20	6	20	28	36	66	HMC4038A052	●
5,30	6	20	28	36	66	HMC4038A053	●
5,40	6	20	28	36	66	HMC4038A054	●
5,50	6	20	28	36	66	HMC4038A055	●
5,60	6	20	28	36	66	HMC4038A056	●

P

Acciaio
Steel
Stahl
Acier

H

Acciaio Temprato
Hardened Steel
Gehärteter Stahl
Acier trempé

K

Ghisa
Cast Iron
Gusseisen
Fonte

M

Acciaio Inox
Stainless Steel
Edelstahl
Acier Inoxydable

S

HRSA - Titanio
HRSA - Titanium
HRSA - Titan
HRSA - Titane

N

Metalli non ferrosi
Non-ferrous metals
NE-Metalle
Matières non ferreuses

O

NON ISO
Not ISO
Keine ISO
Pas d'ISO

● Disponibilità pronta consegna
Availability for prompt delivery

● Consegna 5 giorni data ordine
Delivery 5 days order date

○ Disponibilità su richiesta
Availability on request

180°

d1 m7	d2 h6	lu	l2	l4	l1	Balinit® Latuma Coating	Stock
5,70	6	20	28	36	66	HMC4038A057	●
5,80	6	20	28	36	66	HMC4038A058	●
5,90	6	20	28	36	66	HMC4038A059	●
6,00	6	20	28	36	66	HMC4038A060	●
6,10	8	24	34	36	79	HMC4038A061	●
6,20	8	24	34	36	79	HMC4038A062	●
6,30	8	24	34	36	79	HMC4038A063	●
6,40	8	24	34	36	79	HMC4038A064	●
6,50	8	24	34	36	79	HMC4038A065	●
6,60	8	24	34	36	79	HMC4038A066	●
6,70	8	24	34	36	79	HMC4038A067	●
6,80	8	24	34	36	79	HMC4038A068	●
6,90	8	24	34	36	79	HMC4038A069	●
7,00	8	24	34	36	79	HMC4038A070	●
7,10	8	29	41	36	79	HMC4038A071	●
7,20	8	29	41	36	79	HMC4038A072	●
7,30	8	29	41	36	79	HMC4038A073	●
7,40	8	29	41	36	79	HMC4038A074	●
7,50	8	29	41	36	79	HMC4038A075	●
7,60	8	29	41	36	79	HMC4038A076	●
7,70	8	29	41	36	79	HMC4038A077	●
7,80	8	29	41	36	79	HMC4038A078	●
7,90	8	29	41	36	79	HMC4038A079	●
8,00	8	29	41	36	79	HMC4038A080	●
8,10	10	35	47	40	89	HMC4038A081	●
8,20	10	35	47	40	89	HMC4038A082	●
8,30	10	35	47	40	89	HMC4038A083	●
8,40	10	35	47	40	89	HMC4038A084	●
8,50	10	35	47	40	89	HMC4038A085	●
8,60	10	35	47	40	89	HMC4038A086	●
8,70	10	35	47	40	89	HMC4038A087	●
8,80	10	35	47	40	89	HMC4038A088	●
8,90	10	35	47	40	89	HMC4038A089	●
9,00	10	35	47	40	89	HMC4038A090	●
9,10	10	35	47	40	89	HMC4038A091	●
9,20	10	35	47	40	89	HMC4038A092	●
9,30	10	35	47	40	89	HMC4038A093	●
9,40	10	35	47	40	89	HMC4038A094	●
9,50	10	35	47	40	89	HMC4038A095	●
9,60	10	35	47	40	89	HMC4038A096	●
9,70	10	35	47	40	89	HMC4038A097	●
9,80	10	35	47	40	89	HMC4038A098	●
9,90	10	35	47	40	89	HMC4038A099	●
10,00	10	35	47	40	89	HMC4038A100	●
10,10	12	38	53	45	100	HMC4038A101	●
10,20	12	38	53	45	100	HMC4038A102	●
10,30	12	38	53	45	100	HMC4038A103	●
10,40	12	38	53	45	100	HMC4038A104	●
10,50	12	38	53	45	100	HMC4038A105	●
10,60	12	38	53	45	100	HMC4038A106	●
10,70	12	38	53	45	100	HMC4038A107	●
10,80	12	38	53	45	100	HMC4038A108	●
11,00	12	38	53	45	100	HMC4038A110	●
11,10	12	38	53	45	100	HMC4038A111	●
11,20	12	38	53	45	100	HMC4038A112	●
11,30	12	38	53	45	100	HMC4038A113	●
11,40	12	38	53	45	100	HMC4038A114	●
11,50	12	38	53	45	100	HMC4038A115	●
11,60	12	38	53	45	100	HMC4038A116	●
11,70	12	38	53	45	100	HMC4038A117	●
11,80	12	38	53	45	100	HMC4038A118	●
11,90	12	38	53	45	100	HMC4038A119	●
12,00	12	38	53	45	100	HMC4038A120	●

4038A

Punta piatta 3xD con fori
Flat Drill 3xD with holes
Flachbohrer 3xD mit Kanal
Foret plat 3xD avec trous



Silmax
NORM

DIN
6535 HA
(Standard)



P

K

M

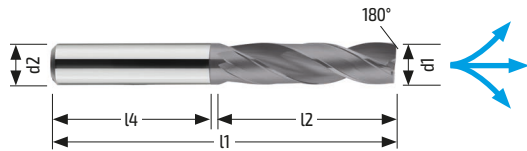

180°

d1 m7	d2 h6	l4	l2	l4	l1	Balinit® Latuma Coating	Stock
12,50	14	41	58	45	105	HMC4038A125	●
12,70	14	41	58	45	105	HMC4038A127	●
12,80	14	41	58	45	105	HMC4038A128	●
13,00	14	41	58	45	105	HMC4038A130	●
13,50	14	41	58	45	105	HMC4038A135	●
13,80	14	41	58	45	105	HMC4038A138	●
14,00	14	41	58	45	105	HMC4038A140	●
14,50	16	43	63	48	113	HMC4038A145	●
14,80	16	43	63	48	113	HMC4038A148	●
15,00	16	43	63	48	113	HMC4038A150	●
15,50	16	43	63	48	113	HMC4038A155	●
15,80	16	43	63	48	113	HMC4038A158	●
16,00	16	43	63	48	113	HMC4038A160	●
16,50	18	49	71	48	121	HMC4038A165	●
16,80	18	49	71	48	121	HMC4038A168	●
17,00	18	49	71	48	121	HMC4038A170	●
17,50	18	49	71	48	121	HMC4038A175	●
18,00	18	49	71	48	121	HMC4038A180	●
18,50	20	53	77	50	129	HMC4038A185	●
18,80	20	53	77	50	129	HMC4038A188	●
19,00	20	53	77	50	129	HMC4038A190	●
19,50	20	53	77	50	129	HMC4038A195	●
20,00	20	53	77	50	129	HMC4038A200	●

4058A

Punta piatta 5xD con fori
Flat Drill 5xD with holes
Flachbohrer 5xD mit Kanal
Foret plats 5xD avec trous



Silmax
NORM

DIN
6535 HA
(Standard)



P

K

M

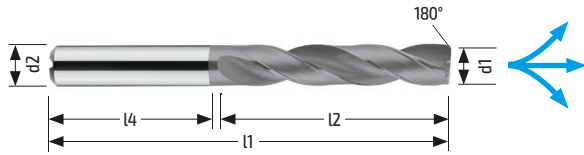

180°

d1 m7	d2	lu	l2	l4	l1	Balinit® Latuma Coating	Stock
3,00	6	23	28	36	66	HMC4058A030	●
3,10	6	23	28	36	66	HMC4058A031	●
3,20	6	23	28	36	66	HMC4058A032	●
3,30	6	23	28	36	66	HMC4058A033	●
3,40	6	23	28	36	66	HMC4058A034	●
3,50	6	23	28	36	66	HMC4058A035	●
3,60	6	23	28	36	66	HMC4058A036	●
3,70	6	23	28	36	66	HMC4058A037	●
3,80	6	29	36	36	74	HMC4058A038	●
3,90	6	29	36	36	74	HMC4058A039	●
4,00	6	29	36	36	74	HMC4058A040	●
4,10	6	29	36	36	74	HMC4058A041	●
4,20	6	29	36	36	74	HMC4058A042	●
4,30	6	29	36	36	74	HMC4058A043	●
4,40	6	29	36	36	74	HMC4058A044	●
4,50	6	29	36	36	74	HMC4058A045	●
4,60	6	29	36	36	74	HMC4058A046	●
4,80	6	35	44	36	82	HMC4058A048	●
4,90	6	35	44	36	82	HMC4058A049	●
5,00	6	35	44	36	82	HMC4058A050	●
5,10	6	35	44	36	82	HMC4058A051	●
5,20	6	35	44	36	82	HMC4058A052	●
5,30	6	35	44	36	82	HMC4058A053	●
5,40	6	35	44	36	82	HMC4058A054	●
5,50	6	35	44	36	82	HMC4058A055	●
5,60	6	35	44	36	82	HMC4058A056	●
5,70	6	35	44	36	82	HMC4058A057	●
5,80	6	35	44	36	82	HMC4058A058	●
5,90	6	35	44	36	82	HMC4058A059	●
6,00	6	35	44	36	82	HMC4058A060	●
6,10	8	43	53	36	91	HMC4058A061	●
6,20	8	43	53	36	91	HMC4058A062	●
6,30	8	43	53	36	91	HMC4058A063	●
6,40	8	43	53	36	91	HMC4058A064	●
6,50	8	43	53	36	91	HMC4058A065	●
6,60	8	43	53	36	91	HMC4058A066	●
6,70	8	43	53	36	91	HMC4058A067	●

P

Acciaio
Steel
Stahl
Acier

H

Acciaio Temprato
Hardened Steel
Gehärteter Stahl
Acier trempé

K

Ghisa
Cast Iron
Gusseisen
Fonte

M

Acciaio Inox
Stainless Steel
Edelstahl
Acier Inoxydable

S

HRSA - Titanio
HRSA - Titanium
HRSA - Titan
HRSA - Titane

N

Metalli non ferrosi
Non-ferrous metals
NE-Metalle
Matières non ferreuses

O

NON ISO
Not ISO
Keine ISO
Pas d'ISO

● Disponibilità pronta consegna
Availability for prompt delivery

● Consegna 5 giorni data ordine
Delivery 5 days order date

○ Disponibilità su richiesta
Availability on request

180°

d1 m7	d2	lu	l2	l4	l1	Balinit® Latuma Coating	Stock
6,80	8	43	53	36	91	HMC4058A068	●
6,90	8	43	53	36	91	HMC4058A069	●
7,00	8	43	53	36	91	HMC4058A070	●
7,10	8	43	53	36	91	HMC4058A071	●
7,20	8	43	53	36	91	HMC4058A072	●
7,30	8	43	53	36	91	HMC4058A073	●
7,40	8	43	53	36	91	HMC4058A074	●
7,50	8	43	53	36	91	HMC4058A075	●
7,60	8	43	53	36	91	HMC4058A076	●
7,80	8	43	53	36	91	HMC4058A078	●
7,90	8	43	53	36	91	HMC4058A079	●
8,00	8	43	53	36	91	HMC4058A080	●
8,10	10	49	61	40	103	HMC4058A081	●
8,20	10	49	61	40	103	HMC4058A082	●
8,30	10	49	61	40	103	HMC4058A083	●
8,40	10	49	61	40	103	HMC4058A084	●
8,50	10	49	61	40	103	HMC4058A085	●
8,60	10	49	61	40	103	HMC4058A086	●
8,70	10	49	61	40	103	HMC4058A087	●
8,80	10	49	61	40	103	HMC4058A088	●
8,90	10	49	61	40	103	HMC4058A089	●
9,00	10	49	61	40	103	HMC4058A090	●
9,10	10	49	61	40	103	HMC4058A091	●
9,20	10	49	61	40	103	HMC4058A092	●
9,30	10	49	61	40	103	HMC4058A093	●
9,40	10	49	61	40	103	HMC4058A094	●
9,50	10	49	61	40	103	HMC4058A095	●
9,60	10	49	61	40	103	HMC4058A096	●
9,70	10	49	61	40	103	HMC4058A097	●
9,80	10	49	61	40	103	HMC4058A098	●
9,90	10	49	61	40	103	HMC4058A099	●
10,00	10	49	61	40	103	HMC4058A100	●
10,10	12	54	69	45	116	HMC4058A101	●
10,20	12	54	69	45	116	HMC4058A102	●
10,30	12	54	69	45	116	HMC4058A103	●
10,40	12	54	69	45	116	HMC4058A104	●
10,50	12	54	69	45	116	HMC4058A105	●
10,60	12	54	69	45	116	HMC4058A106	●
10,65	12	54	69	45	116	HMC4058A107	●
10,80	12	54	69	45	116	HMC4058A108	●
11,00	12	54	69	45	116	HMC4058A110	●
11,20	12	54	69	45	116	HMC4058A112	●
11,50	12	54	69	45	116	HMC4058A115	●
11,60	12	54	69	45	116	HMC4058A116	●
11,70	12	54	69	45	116	HMC4058A117	●
11,80	12	54	69	45	116	HMC4058A118	●
12,00	12	54	69	45	116	HMC4058A120	●
12,50	14	58	75	45	122	HMC4058A125	●
12,80	14	58	75	45	122	HMC4058A128	●
13,00	14	58	75	45	122	HMC4058A130	●
13,50	14	58	75	45	122	HMC4058A135	●
13,80	14	58	75	45	122	HMC4058A138	●
14,00	14	58	75	45	122	HMC4058A140	●
14,50	16	61	81	48	131	HMC4058A145	●
14,80	16	61	81	48	131	HMC4058A148	●
15,00	16	61	81	48	131	HMC4058A150	●
15,50	16	61	81	48	131	HMC4058A155	●
15,80	16	61	81	48	131	HMC4058A158	●
16,00	16	61	81	48	131	HMC4058A160	●
16,50	18	69	91	48	141	HMC4058A165	●
17,00	18	69	91	48	141	HMC4058A170	●
17,50	18	69	91	48	141	HMC4058A175	●
17,80	18	69	91	48	141	HMC4058A178	●

4058A

Punta piatta 5xD con fori
 Flat Drill 5xD with holes
 Flachbohrer 5xD mit Kanal
 Foret plats 5xD avec trous



Silmax
NORM

DIN
6535 HA
(Standard)



P

K

M

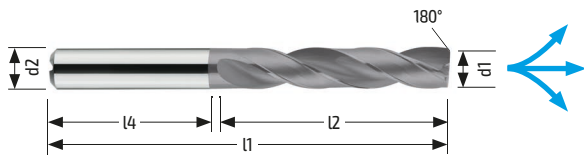

180°

d1 m7	d2	l4	l2	l1	Balinit® Latuma Coating	Stock
18,00	18	69	91	48	HMC4058A180	●
18,50	20	75	99	50	HMC4058A185	●
19,00	20	75	99	50	HMC4058A190	●
19,80	20	75	99	50	HMC4058A198	●
20,00	20	75	99	50	HMC4058A200	●

PUNTE HM PER ACCIAIO INOX FINO 8xD

HM DRILLS FOR INOX UP TO 8xD / HM-BOHRER FÜR EDELSTAHL BIS ZU 8xD /
FORETS HM POUR ACIER INOXYDABLE JUSQU'À 8xD

3031S

Punta 3xD con fori
3xD Drill with internal coolant
3xD Bohrer mit IK
3xD Foret avec trous de lubrification

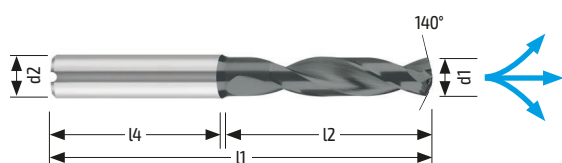
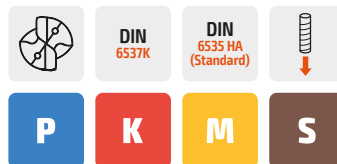

140°	d1 m7	d2 h6	lu	l2	l4	l1	Balinit® Latuma Coating	Stock
	3,00	6	14	20	36	62	HMC3031S030	●
	3,10	6	14	20	36	62	HMC3031S031	○
	3,20	6	14	20	36	62	HMC3031S032	●
	3,30	6	14	20	36	62	HMC3031S033	●
	3,40	6	14	20	36	62	HMC3031S034	○
	3,50	6	14	20	36	62	HMC3031S035	●
	3,60	6	14	20	36	62	HMC3031S036	○
	3,70	6	14	20	36	62	HMC3031S037	○
	3,80	6	17	24	36	66	HMC3031S038	○
	3,90	6	17	24	36	66	HMC3031S039	○
	4,00	6	17	24	36	66	HMC3031S040	●
	4,10	6	17	24	36	66	HMC3031S041	●
	4,20	6	17	24	36	66	HMC3031S042	●
	4,30	6	17	24	36	66	HMC3031S043	○
	4,40	6	17	24	36	66	HMC3031S044	●
	4,50	6	17	24	36	66	HMC3031S045	●
	4,60	6	17	24	36	66	HMC3031S046	○
	4,70	6	17	24	36	66	HMC3031S047	○
	4,80	6	20	28	36	66	HMC3031S048	○
	4,90	6	20	28	36	66	HMC3031S049	●
	5,00	6	20	28	36	66	HMC3031S050	●
	5,10	6	20	28	36	66	HMC3031S051	●
	5,20	6	20	28	36	66	HMC3031S052	○
	5,30	6	20	28	36	66	HMC3031S053	○
	5,40	6	20	28	36	66	HMC3031S054	○
	5,50	6	20	28	36	66	HMC3031S055	●
	5,60	6	20	28	36	66	HMC3031S056	○
	5,70	6	20	28	36	66	HMC3031S057	○

P

Acciaio
Steel
Stahl
Acier

H

Acciaio Temprato
Hardened Steel
Gehärteter Stahl
Acier trempé

K

Ghisa
Cast Iron
Gusseisen
Fonte

M

Acciaio Inox
Stainless Steel
Edelstahl
Acier Inoxydable

S

HRSA - Titanio
HRSA - Titanium
HRSA - Titan
HRSA - Titane

N

Metalli non ferrosi
Non-ferrous metals
NE-Metalle
Matières non ferreuses

O

NON ISO
Not ISO
Keine ISO
Pas d'ISO

● Disponibilità pronta consegna
Availability for prompt delivery

◐ Consegna 5 giorni data ordine
Delivery 5 days order date

○ Disponibilità su richiesta
Availability on request

140°

d1 m7	d2 h6	lu	l2	l4	l1	Balinit® Latuma Coating	Stock
5,80	6	20	28	36	66	HMC3031S058	○
5,90	6	20	28	36	66	HMC3031S059	○
6,00	6	20	28	36	66	HMC3031S060	●
6,10	8	24	34	36	79	HMC3031S061	○
6,20	8	24	34	36	79	HMC3031S062	○
6,30	8	24	34	36	79	HMC3031S063	○
6,40	8	24	34	36	79	HMC3031S064	○
6,50	8	24	34	36	79	HMC3031S065	●
6,60	8	24	34	36	79	HMC3031S066	○
6,70	8	24	34	36	79	HMC3031S067	●
6,80	8	24	34	36	79	HMC3031S068	●
6,90	8	24	34	36	79	HMC3031S069	○
7,00	8	24	34	36	79	HMC3031S070	●
7,10	8	29	41	36	79	HMC3031S071	○
7,20	8	29	41	36	79	HMC3031S072	○
7,30	8	29	41	36	79	HMC3031S073	○
7,40	8	29	41	36	79	HMC3031S074	○
7,50	8	29	41	36	79	HMC3031S075	●
7,60	8	29	41	36	79	HMC3031S076	○
7,70	8	29	41	36	79	HMC3031S077	○
7,80	8	29	41	36	79	HMC3031S078	○
7,90	8	29	41	36	79	HMC3031S079	○
8,00	8	29	41	36	79	HMC3031S080	●
8,10	10	35	47	40	89	HMC3031S081	○
8,20	10	35	47	40	89	HMC3031S082	○
8,30	10	35	47	40	89	HMC3031S083	○
8,40	10	35	47	40	89	HMC3031S084	●
8,50	10	35	47	40	89	HMC3031S085	●
8,60	10	35	47	40	89	HMC3031S086	○
8,70	10	35	47	40	89	HMC3031S087	○
8,80	10	35	47	40	89	HMC3031S088	○
8,90	10	35	47	40	89	HMC3031S089	○
9,00	10	35	47	40	89	HMC3031S090	●
9,10	10	35	47	40	89	HMC3031S091	○
9,20	10	35	47	40	89	HMC3031S092	○
9,30	10	35	47	40	89	HMC3031S093	○
9,40	10	35	47	40	89	HMC3031S094	○
9,50	10	35	47	40	89	HMC3031S095	●
9,60	10	35	47	40	89	HMC3031S096	○
9,70	10	35	47	40	89	HMC3031S097	○
9,80	10	35	47	40	89	HMC3031S098	○
9,90	10	35	47	40	89	HMC3031S099	○
10,00	10	35	47	40	89	HMC3031S100	●
10,10	12	40	55	45	102	HMC3031S101	●
10,20	12	40	55	45	102	HMC3031S102	●
10,30	12	40	55	45	102	HMC3031S103	○
10,40	12	40	55	45	102	HMC3031S104	○
10,50	12	40	55	45	102	HMC3031S105	●
10,60	12	40	55	45	102	HMC3031S106	○
10,70	12	40	55	45	102	HMC3031S107	○
10,80	12	40	55	45	102	HMC3031S108	○
10,90	12	40	55	45	102	HMC3031S109	○
11,00	12	40	55	45	102	HMC3031S110	●
11,10	12	40	55	45	102	HMC3031S111	○
11,20	12	40	55	45	102	HMC3031S112	○
11,30	12	40	55	45	102	HMC3031S113	○
11,40	12	40	55	45	102	HMC3031S114	○
11,50	12	40	55	45	102	HMC3031S115	●
11,60	12	40	55	45	102	HMC3031S116	○
11,70	12	40	55	45	102	HMC3031S117	○
11,80	12	40	55	45	102	HMC3031S118	○
11,90	12	40	55	45	102	HMC3031S119	○
12,00	12	40	55	45	102	HMC3031S120	●
12,10	14	43	60	45	107	HMC3031S121	○
12,20	14	43	60	45	107	HMC3031S122	○
12,30	14	43	60	45	107	HMC3031S123	○

3031S

Punta 3xD con fori
3xD Drill with internal coolant
3xD Bohrer mit IK
3xD Foret avec trous de lubrification



DIN
6537K

DIN
6535 HA
(Standard)



P

K

M

S

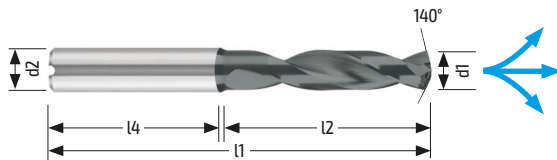

140°

d1 m7	d2 h6	lu	l2	l4	l1	Balinit® Latuma Coating	Stock
12,40	14	43	60	45	107	HMC3031S124	○
12,50	14	43	60	45	107	HMC3031S125	●
12,60	14	43	60	45	107	HMC3031S126	○
12,70	14	43	60	45	107	HMC3031S127	○
12,80	14	43	60	45	107	HMC3031S128	○
12,90	14	43	60	45	107	HMC3031S129	○
13,00	14	43	60	45	107	HMC3031S130	●
13,10	14	43	60	45	107	HMC3031S131	○
13,20	14	43	60	45	107	HMC3031S132	○
13,30	14	43	60	45	107	HMC3031S133	○
13,40	14	43	60	45	107	HMC3031S134	○
13,50	14	43	60	45	107	HMC3031S135	●
13,60	14	43	60	45	107	HMC3031S136	○
13,70	14	43	60	45	107	HMC3031S137	○
13,80	14	43	60	45	107	HMC3031S138	○
13,90	14	43	60	45	107	HMC3031S139	○
14,00	14	43	60	45	107	HMC3031S140	●
14,10	16	45	65	48	115	HMC3031S141	○
14,20	16	45	65	48	115	HMC3031S142	○
14,30	16	45	65	48	115	HMC3031S143	○
14,40	16	45	65	48	115	HMC3031S144	○
14,50	16	45	65	48	115	HMC3031S145	○
14,60	16	45	65	48	115	HMC3031S146	○
14,70	16	45	65	48	115	HMC3031S147	○
14,80	16	45	65	48	115	HMC3031S148	○
14,90	16	45	65	48	115	HMC3031S149	○
15,00	16	45	65	48	115	HMC3031S150	○
15,10	16	45	65	48	115	HMC3031S151	○
15,20	16	45	65	48	115	HMC3031S152	○
15,30	16	45	65	48	115	HMC3031S153	○
15,40	16	45	65	48	115	HMC3031S154	○
15,50	16	45	65	48	115	HMC3031S155	○
15,60	16	45	65	48	115	HMC3031S156	○
15,70	16	45	65	48	115	HMC3031S157	○
15,80	16	45	65	48	115	HMC3031S158	○
15,90	16	45	65	48	115	HMC3031S159	○
16,00	16	45	65	48	115	HMC3031S160	○
16,10	18	52	73	48	123	HMC3031S161	○
16,20	18	52	73	48	123	HMC3031S162	○
16,30	18	52	73	48	123	HMC3031S163	○
16,40	18	52	73	48	123	HMC3031S164	○
16,50	18	52	73	48	123	HMC3031S165	○
16,60	18	52	73	48	123	HMC3031S166	○
16,70	18	52	73	48	123	HMC3031S167	○
16,80	18	52	73	48	123	HMC3031S168	○
16,90	18	52	73	48	123	HMC3031S169	○
17,00	18	52	73	48	123	HMC3031S170	○
17,10	18	52	73	48	123	HMC3031S171	○
17,20	18	52	73	48	123	HMC3031S172	○
17,30	18	52	73	48	123	HMC3031S173	○

140°

d1 m7	d2 h6	lu	l2	l4	l1	Balinit® Latuma Coating	Stock
17,40	18	52	73	48	123	HMC3031S174	○
17,50	18	52	73	48	123	HMC3031S175	○
17,60	18	52	73	48	123	HMC3031S176	○
17,70	18	52	73	48	123	HMC3031S177	○
17,80	18	52	73	48	123	HMC3031S178	○
17,90	18	52	73	48	123	HMC3031S179	○
18,00	18	52	73	48	123	HMC3031S180	○
18,10	20	57	79	50	131	HMC3031S181	○
18,20	20	57	79	50	131	HMC3031S182	○
18,30	20	57	79	50	131	HMC3031S183	○
18,40	20	57	79	50	131	HMC3031S184	○
18,50	20	57	79	50	131	HMC3031S185	○
18,60	20	57	79	50	131	HMC3031S186	○
18,70	20	57	79	50	131	HMC3031S187	○
18,80	20	57	79	50	131	HMC3031S188	○
18,90	20	57	79	50	131	HMC3031S189	○
19,00	20	57	79	50	131	HMC3031S190	○
19,10	20	57	79	50	131	HMC3031S191	○
19,20	20	57	79	50	131	HMC3031S192	○
19,30	20	57	79	50	131	HMC3031S193	○
19,40	20	57	79	50	131	HMC3031S194	○
19,50	20	57	79	50	131	HMC3031S195	○
19,60	20	57	79	50	131	HMC3031S196	○
19,70	20	57	79	50	131	HMC3031S197	○
19,80	20	57	79	50	131	HMC3031S198	○
19,90	20	57	79	50	131	HMC3031S199	○
20,00	20	57	79	50	131	HMC3031S200	○

Notes

3051S

Punta 5xD con fori
5xD Drill with internal coolant
5xD Bohrer mit IK
5xD Foret avec trous de lubrification

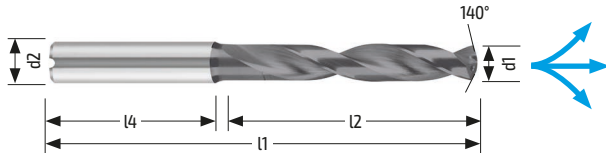
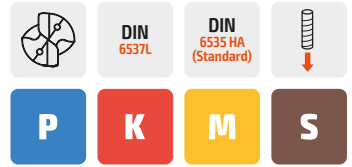

140°	d1 m7	d2 h6	lu	l2	l4	l1	Balinit® Latuma Coating	Stock
	3,00	6	23	27	36	66	HMC3051S030	●
	3,10	6	23	27	36	66	HMC3051S031	○
	3,20	6	23	27	36	66	HMC3051S032	●
	3,30	6	23	27	36	66	HMC3051S033	●
	3,40	6	23	27	36	66	HMC3051S034	○
	3,50	6	23	27	36	66	HMC3051S035	●
	3,60	6	23	27	36	66	HMC3051S036	○
	3,70	6	23	27	36	66	HMC3051S037	○
	3,80	6	29	36	36	74	HMC3051S038	○
	3,90	6	29	36	36	74	HMC3051S039	○
	4,00	6	29	36	36	74	HMC3051S040	●
	4,10	6	29	36	36	74	HMC3051S041	●
	4,20	6	29	36	36	74	HMC3051S042	●
	4,30	6	29	36	36	74	HMC3051S043	○
	4,40	6	29	36	36	74	HMC3051S044	○
	4,50	6	29	36	36	74	HMC3051S045	●
	4,60	6	29	36	36	74	HMC3051S046	○
	4,70	6	29	36	36	74	HMC3051S047	○
	4,80	6	35	44	36	82	HMC3051S048	○
	4,90	6	35	44	36	82	HMC3051S049	●
	5,00	6	35	44	36	82	HMC3051S050	●
	5,10	6	35	44	36	82	HMC3051S051	○
	5,20	6	35	44	36	82	HMC3051S052	●
	5,30	6	35	44	36	82	HMC3051S053	○
	5,40	6	35	44	36	82	HMC3051S054	○
	5,50	6	35	44	36	82	HMC3051S055	●
	5,60	6	35	44	36	82	HMC3051S056	○
	5,70	6	35	44	36	82	HMC3051S057	○
	5,80	6	35	44	36	82	HMC3051S058	○
	5,90	6	35	44	36	82	HMC3051S059	○
	6,00	6	35	44	36	82	HMC3051S060	●
	6,10	8	43	53	36	91	HMC3051S061	○
	6,20	8	43	53	36	91	HMC3051S062	○
	6,30	8	43	53	36	91	HMC3051S063	○
	6,40	8	43	53	36	91	HMC3051S064	○
	6,50	8	43	53	36	91	HMC3051S065	●

P

Acciaio
Steel
Stahl
Acier

H

Acciaio Temprato
Hardened Steel
Gehärteter Stahl
Acier trempé

K

Ghisa
Cast Iron
Gusseisen
Fonte

M

Acciaio Inox
Stainless Steel
Edelstahl
Acier Inoxydable

S

HRSA - Titanio
HRSA - Titanium
HRSA - Titan
HRSA - Titane

N

Metalli non ferrosi
Non-ferrous metals
NE-Metalle
Matières non ferreuses

O

NON ISO
Not ISO
Keine ISO
Pas d'ISO

● **Disponibilità pronta consegna**
Availability for prompt delivery

⦿ **Consegna 5 giorni data ordine**
Delivery 5 days order date

○ **Disponibilità su richiesta**
Availability on request

140°

d1 m7	d2 h6	lu	l2	l4	l1	Balinit® Latuma Coating	Stock
6,60	8	43	53	36	91	HMC3051S066	○
6,70	8	43	53	36	91	HMC3051S067	●
6,80	8	43	53	36	91	HMC3051S068	●
6,90	8	43	53	36	91	HMC3051S069	○
7,00	8	43	53	36	91	HMC3051S070	●
7,10	8	43	53	36	91	HMC3051S071	○
7,20	8	43	53	36	91	HMC3051S072	○
7,30	8	43	53	36	91	HMC3051S073	○
7,40	8	43	53	36	91	HMC3051S074	○
7,50	8	43	53	36	91	HMC3051S075	●
7,60	8	43	53	36	91	HMC3051S076	○
7,70	8	43	53	36	91	HMC3051S077	○
7,80	8	43	53	36	91	HMC3051S078	○
7,90	8	43	53	36	91	HMC3051S079	○
8,00	8	43	53	36	91	HMC3051S080	●
8,10	10	49	61	40	103	HMC3051S081	○
8,20	10	49	61	40	103	HMC3051S082	○
8,30	10	49	61	40	103	HMC3051S083	○
8,40	10	49	61	40	103	HMC3051S084	●
8,50	10	49	61	40	103	HMC3051S085	●
8,60	10	49	61	40	103	HMC3051S086	○
8,70	10	49	61	40	103	HMC3051S087	●
8,80	10	49	61	40	103	HMC3051S088	●
8,90	10	49	61	40	103	HMC3051S089	○
9,00	10	49	61	40	103	HMC3051S090	●
9,10	10	49	61	40	103	HMC3051S091	○
9,20	10	49	61	40	103	HMC3051S092	○
9,30	10	49	61	40	103	HMC3051S093	○
9,40	10	49	61	40	103	HMC3051S094	○
9,50	10	49	61	40	103	HMC3051S095	●
9,60	10	49	61	40	103	HMC3051S096	○
9,70	10	49	61	40	103	HMC3051S097	○
9,80	10	49	61	40	103	HMC3051S098	○
9,90	10	49	61	40	103	HMC3051S099	○
10,00	10	49	61	40	103	HMC3051S100	●
10,10	12	56	71	45	118	HMC3051S101	●
10,20	12	56	71	45	118	HMC3051S102	●
10,30	12	56	71	45	118	HMC3051S103	○
10,40	12	56	71	45	118	HMC3051S104	○
10,50	12	56	71	45	118	HMC3051S105	●
10,60	12	56	71	45	118	HMC3051S106	○
10,70	12	56	71	45	118	HMC3051S107	○
10,80	12	56	71	45	118	HMC3051S108	●
10,90	12	56	71	45	118	HMC3051S109	○
11,00	12	56	71	45	118	HMC3051S110	●
11,10	12	56	71	45	118	HMC3051S111	○
11,20	12	56	71	45	118	HMC3051S112	○
11,30	12	56	71	45	118	HMC3051S113	○
11,40	12	56	71	45	118	HMC3051S114	○
11,50	12	56	71	45	118	HMC3051S115	●
11,60	12	56	71	45	118	HMC3051S116	○
11,70	12	56	71	45	118	HMC3051S117	○
11,80	12	56	71	45	118	HMC3051S118	○
11,90	12	56	71	45	118	HMC3051S119	○
12,00	12	56	71	45	118	HMC3051S120	●
12,10	14	60	77	45	124	HMC3051S121	○
12,20	14	60	77	45	124	HMC3051S122	○
12,30	14	60	77	45	124	HMC3051S123	○
12,40	14	60	77	45	124	HMC3051S124	○
12,50	14	60	77	45	124	HMC3051S125	●
12,60	14	60	77	45	124	HMC3051S126	○
12,70	14	60	77	45	124	HMC3051S127	○
12,80	14	60	77	45	124	HMC3051S128	○
12,90	14	60	77	45	124	HMC3051S129	○

3051S

Punta 5xD con fori
5xD Drill with internal coolant
5xD Bohrer mit IK
5xD Foret avec trous de lubrification

DIN
6537LDIN
6535 HA
(Standard)

P

K

M

S

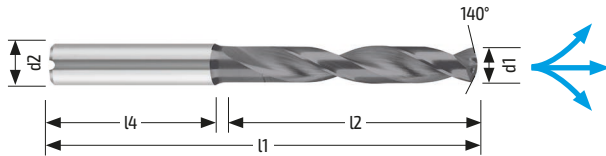

140°

d1 m7	d2 h6	lu	l2	l4	l1	Balinit® Latuma Coating	Stock
13,00	14	60	77	45	124	HMC3051S130	●
13,10	14	60	77	45	124	HMC3051S131	○
13,20	14	60	77	45	124	HMC3051S132	○
13,30	14	60	77	45	124	HMC3051S133	○
13,40	14	60	77	45	124	HMC3051S134	○
13,50	14	60	77	45	124	HMC3051S135	●
13,60	14	60	77	45	124	HMC3051S136	○
13,70	14	60	77	45	124	HMC3051S137	○
13,80	14	60	77	45	124	HMC3051S138	●
13,90	14	60	77	45	124	HMC3051S139	○
14,00	14	60	77	45	124	HMC3051S140	●
14,10	16	63	83	48	133	HMC3051S141	○
14,20	16	63	83	48	133	HMC3051S142	○
14,30	16	63	83	48	133	HMC3051S143	○
14,40	16	63	83	48	133	HMC3051S144	○
14,50	16	63	83	48	133	HMC3051S145	●
14,60	16	63	83	48	133	HMC3051S146	○
14,70	16	63	83	48	133	HMC3051S147	○
14,80	16	63	83	48	133	HMC3051S148	○
14,90	16	63	83	48	133	HMC3051S149	○
15,00	16	63	83	48	133	HMC3051S150	●
15,10	16	63	83	48	133	HMC3051S151	○
15,20	16	63	83	48	133	HMC3051S152	○
15,30	16	63	83	48	133	HMC3051S153	○
15,40	16	63	83	48	133	HMC3051S154	○
15,50	16	63	83	48	133	HMC3051S155	○
15,60	16	63	83	48	133	HMC3051S156	○
15,70	16	63	83	48	133	HMC3051S157	○
15,80	16	63	83	48	133	HMC3051S158	○
15,90	16	63	83	48	133	HMC3051S159	○
16,00	16	63	83	48	133	HMC3051S160	●
16,10	18	72	93	48	143	HMC3051S161	○
16,20	18	72	93	48	143	HMC3051S162	○
16,30	18	72	93	48	143	HMC3051S163	○
16,40	18	72	93	48	143	HMC3051S164	○
16,50	18	72	93	48	143	HMC3051S165	○
16,60	18	72	93	48	143	HMC3051S166	○
16,70	18	72	93	48	143	HMC3051S167	○
16,80	18	72	93	48	143	HMC3051S168	○
16,90	18	72	93	48	143	HMC3051S169	○
17,00	18	72	93	48	143	HMC3051S170	○
17,10	18	72	93	48	143	HMC3051S171	○
17,20	18	72	93	48	143	HMC3051S172	○
17,30	18	72	93	48	143	HMC3051S173	○
17,40	18	72	93	48	143	HMC3051S174	○
17,50	18	72	93	48	143	HMC3051S175	○
17,60	18	72	93	48	143	HMC3051S176	○
17,70	18	72	93	48	143	HMC3051S177	○
17,80	18	72	93	48	143	HMC3051S178	○
17,90	18	72	93	48	143	HMC3051S179	○

140°

d1 m7	d2 h6	lu	l2	l4	l1	Balinit® Latuma Coating	Stock
18,00	18	72	93	48	143	HMC3051S180	○
18,10	20	79	101	50	153	HMC3051S181	○
18,20	20	79	101	50	153	HMC3051S182	○
18,30	20	79	101	50	153	HMC3051S183	○
18,40	20	79	101	50	153	HMC3051S184	○
18,50	20	79	101	50	153	HMC3051S185	○
18,60	20	79	101	50	153	HMC3051S186	○
18,70	20	79	101	50	153	HMC3051S187	○
18,80	20	79	101	50	153	HMC3051S188	○
18,90	20	79	101	50	153	HMC3051S189	○
19,00	20	79	101	50	153	HMC3051S190	○
19,10	20	79	101	50	153	HMC3051S191	○
19,20	20	79	101	50	153	HMC3051S192	○
19,30	20	79	101	50	153	HMC3051S193	○
19,40	20	79	101	50	153	HMC3051S194	○
19,50	20	79	101	50	153	HMC3051S195	○
19,60	20	79	101	50	153	HMC3051S196	○
19,70	20	79	101	50	153	HMC3051S197	○
19,80	20	79	101	50	153	HMC3051S198	○
19,90	20	79	101	50	153	HMC3051S199	○
20,00	20	79	101	50	153	HMC3051S200	○

Notes

3081S

Punta 8xD con fori
8xD Drill with internal coolant
8xD Bohrer mit IK
8xD Foret avec trous de lubrification

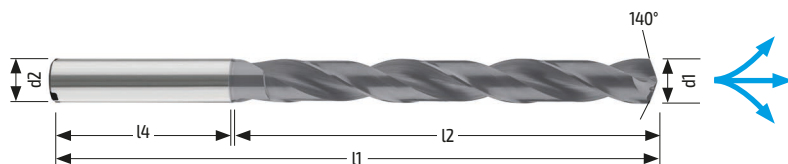
SILMAX
NORMDIN
6535 HA
(Standard)

140°

d1 h8	d2 h6	lu	l2	l4	l1	Balinit® Latuma Coating	Stock
3,00	6	29	35	36	74	HMC3081S030	●
3,10	6	30	35	36	74	HMC3081S031	○
3,20	6	30	35	36	74	HMC3081S032	○
3,30	6	30	35	36	74	HMC3081S033	○
3,40	6	30	35	36	74	HMC3081S034	○
3,50	6	30	35	36	74	HMC3081S035	●
3,60	6	30	35	36	74	HMC3081S036	○
3,70	6	30	35	36	74	HMC3081S037	○
3,80	6	37	44	36	82	HMC3081S038	○
3,90	6	37	44	36	82	HMC3081S039	○
4,00	6	37	44	36	82	HMC3081S040	●
4,10	6	37	44	36	82	HMC3081S041	○
4,20	6	37	44	36	82	HMC3081S042	○
4,30	6	37	44	36	82	HMC3081S043	○
4,40	6	37	44	36	82	HMC3081S044	○
4,50	6	37	44	36	82	HMC3081S045	●
4,60	6	37	44	36	82	HMC3081S046	○
4,70	6	48	57	36	82	HMC3081S047	○
4,80	6	48	57	36	95	HMC3081S048	○
4,90	6	48	57	36	95	HMC3081S049	○
5,00	6	48	57	36	95	HMC3081S050	●
5,10	6	48	57	36	95	HMC3081S051	○
5,20	6	48	57	36	95	HMC3081S052	○
5,30	6	48	57	36	95	HMC3081S053	○
5,40	6	48	57	36	95	HMC3081S054	○
5,50	6	48	57	36	95	HMC3081S055	●
5,60	6	48	57	36	95	HMC3081S056	○
5,70	6	48	57	36	95	HMC3081S057	○
5,80	6	48	57	36	95	HMC3081S058	○
5,90	6	48	57	36	95	HMC3081S059	○
6,00	6	48	57	36	95	HMC3081S060	●
6,10	8	66	76	36	114	HMC3081S061	○
6,20	8	66	76	36	114	HMC3081S062	○
6,30	8	66	76	36	114	HMC3081S063	○
6,40	8	66	76	36	114	HMC3081S064	○
6,50	8	66	76	36	114	HMC3081S065	●

P

Acciaio
Steel
Stahl
Acier

H

Acciaio Temprato
Hardened Steel
Gehärteter Stahl
Acier trempé

K

Ghisa
Cast Iron
Gusseisen
Fonte

M

Acciaio Inox
Stainless Steel
Edelstahl
Acier Inoxydable

S

HRSA - Titanio
HRSA - Titanium
HRSA - Titan
HRSA - Titane

N

Metalli non ferrosi
Non-ferrous metals
NE-Metalle
Matières non ferreuses

O

NON ISO
Not ISO
Keine ISO
Pas d'ISO

● Disponibilità pronta consegna
Availability for prompt delivery

⌚ Consegna 5 giorni data ordine
Delivery 5 days order date

○ Disponibilità su richiesta
Availability on request

140°

d1 h8	d2 h6	lu	l2	l4	l1	Balinit® Latuma Coating	Stock
6,60	8	66	76	36	114	HMC3081S066	○
6,70	8	66	76	36	114	HMC3081S067	○
6,80	8	66	76	36	114	HMC3081S068	○
6,90	8	66	76	36	114	HMC3081S069	○
7,00	8	66	76	36	114	HMC3081S070	●
7,10	8	66	76	36	114	HMC3081S071	○
7,20	8	66	76	36	114	HMC3081S072	○
7,30	8	66	76	36	114	HMC3081S073	○
7,40	8	66	76	36	114	HMC3081S074	○
7,50	8	66	76	36	114	HMC3081S075	●
7,60	8	66	76	36	114	HMC3081S076	○
7,70	8	66	76	36	114	HMC3081S077	○
7,80	8	66	76	36	114	HMC3081S078	○
7,90	8	66	76	36	114	HMC3081S079	○
8,00	8	66	76	36	114	HMC3081S080	●
8,10	10	84	96	40	138	HMC3081S081	○
8,20	10	84	96	40	138	HMC3081S082	○
8,30	10	84	96	40	138	HMC3081S083	○
8,40	10	84	96	40	138	HMC3081S084	○
8,50	10	84	96	40	138	HMC3081S085	●
8,60	10	84	96	40	138	HMC3081S086	○
8,70	10	84	96	40	138	HMC3081S087	○
8,80	10	84	96	40	138	HMC3081S088	○
8,90	10	84	96	40	138	HMC3081S089	○
9,00	10	84	96	40	138	HMC3081S090	●
9,10	10	84	96	40	138	HMC3081S091	○
9,20	10	84	96	40	138	HMC3081S092	○
9,30	10	84	96	40	138	HMC3081S093	○
9,40	10	84	96	40	138	HMC3081S094	○
9,50	10	84	96	40	138	HMC3081S095	○
9,60	10	84	96	40	138	HMC3081S096	○
9,70	10	84	96	40	138	HMC3081S097	○
9,80	10	84	96	40	138	HMC3081S098	○
9,90	10	84	96	40	138	HMC3081S099	○
10,00	10	84	96	40	138	HMC3081S100	●
10,10	12	100	115	45	162	HMC3081S101	○
10,20	12	100	115	45	162	HMC3081S102	○
10,30	12	100	115	45	162	HMC3081S103	○
10,40	12	100	115	45	162	HMC3081S104	○
10,50	12	100	115	45	162	HMC3081S105	●
10,60	12	100	115	45	162	HMC3081S106	○
10,70	12	100	115	45	162	HMC3081S107	○
10,80	12	100	115	45	162	HMC3081S108	○
10,90	12	100	115	45	162	HMC3081S109	○
11,00	12	100	115	45	162	HMC3081S110	●
11,10	12	100	115	45	162	HMC3081S111	○
11,20	12	100	115	45	162	HMC3081S112	○
11,30	12	100	115	45	162	HMC3081S113	○
11,40	12	100	115	45	162	HMC3081S114	○
11,50	12	100	115	45	162	HMC3081S115	○
11,60	12	100	115	45	162	HMC3081S116	○
11,70	12	100	115	45	162	HMC3081S117	○
11,80	12	100	115	45	162	HMC3081S118	○
11,90	12	100	115	45	162	HMC3081S119	○
12,00	12	100	115	45	162	HMC3081S120	●
12,10	14	117	134	45	181	HMC3081S121	○
12,20	14	117	134	45	181	HMC3081S122	○
12,30	14	117	134	45	181	HMC3081S123	○
12,40	14	117	134	45	181	HMC3081S124	○
12,50	14	117	134	45	181	HMC3081S125	○
12,60	14	117	134	45	181	HMC3081S126	○
12,70	14	117	134	45	181	HMC3081S127	○
12,80	14	117	134	45	181	HMC3081S128	○
12,90	14	117	134	45	181	HMC3081S129	○

3081S

Punta 8xD con fori
8xD Drill with internal coolant
8xD Bohrer mit IK
8xD Foret avec trous de lubrification



Silmax
NORM

DIN
6535 HA
(Standard)

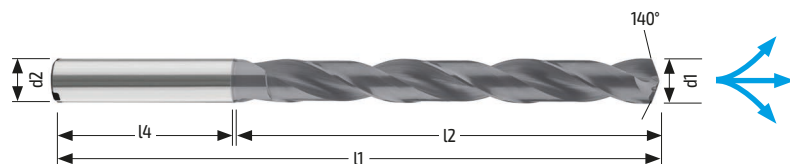

140°

d1 h8	d2 h6	lu	l2	l4	l1	Balinit® Latuma Coating	Stock
13,00	14	117	134	45	181	HMC3081S130	○
13,10	14	117	134	45	181	HMC3081S131	○
13,20	14	117	134	45	181	HMC3081S132	○
13,30	14	117	134	45	181	HMC3081S133	○
13,40	14	117	134	45	181	HMC3081S134	○
13,50	14	117	134	45	181	HMC3081S135	○
13,60	14	117	134	45	181	HMC3081S136	○
13,70	14	117	134	45	181	HMC3081S137	○
13,80	14	117	134	45	181	HMC3081S138	○
13,90	14	117	134	45	181	HMC3081S139	○
14,00	14	117	134	45	181	HMC3081S140	○
14,10	16	133	153	48	203	HMC3081S141	○
14,20	16	133	153	48	203	HMC3081S142	○
14,30	16	133	153	48	203	HMC3081S143	○
14,40	16	133	153	48	203	HMC3081S144	○
14,50	16	133	153	48	203	HMC3081S145	○
14,60	16	133	153	48	203	HMC3081S146	○
14,70	16	133	153	48	203	HMC3081S147	○
14,80	16	133	153	48	203	HMC3081S148	○
14,90	16	133	153	48	203	HMC3081S149	○
15,00	16	133	153	48	203	HMC3081S150	○
15,10	16	133	153	48	203	HMC3081S151	○
15,20	16	133	153	48	203	HMC3081S152	○
15,30	16	133	153	48	203	HMC3081S153	○
15,40	16	133	153	48	203	HMC3081S154	○
15,50	16	133	153	48	203	HMC3081S155	○
15,60	16	133	153	48	203	HMC3081S156	○
15,70	16	133	153	48	203	HMC3081S157	○
15,80	16	133	153	48	203	HMC3081S158	○
15,90	16	133	153	48	203	HMC3081S159	○
16,00	16	133	153	48	203	HMC3081S160	○
16,10	18	150	171	48	223	HMC3081S161	○
16,20	18	150	171	48	223	HMC3081S162	○
16,30	18	150	171	48	223	HMC3081S163	○
16,40	18	150	171	48	223	HMC3081S164	○
16,50	18	150	171	48	223	HMC3081S165	○
16,60	18	150	171	48	223	HMC3081S166	○
16,70	18	150	171	48	223	HMC3081S167	○
16,80	18	150	171	48	223	HMC3081S168	○
16,90	18	150	171	48	223	HMC3081S169	○
17,00	18	150	171	48	223	HMC3081S170	○
17,10	18	150	171	48	223	HMC3081S171	○
17,20	18	150	171	48	223	HMC3081S172	○
17,30	18	150	171	48	223	HMC3081S173	○
17,40	18	150	171	48	223	HMC3081S174	○
17,50	18	150	171	48	223	HMC3081S175	○
17,60	18	150	171	48	223	HMC3081S176	○

140°

d1 h8	d2 h6	lu	l2	l4	l1	Balinit® Latuma Coating	Stock
17,70	18	150	171	48	223	HMC3081S177	○
17,80	18	150	171	48	223	HMC3081S178	○
17,90	18	150	171	48	223	HMC3081S179	○
18,00	18	150	171	48	223	HMC3081S180	○
18,10	20	168	190	50	244	HMC3081S181	○
18,20	20	168	190	50	244	HMC3081S182	○
18,30	20	168	190	50	244	HMC3081S183	○
18,40	20	168	190	50	244	HMC3081S184	○
18,50	20	168	190	50	244	HMC3081S185	○
18,60	20	168	190	50	244	HMC3081S186	○
18,70	20	168	190	50	244	HMC3081S187	○
18,80	20	168	190	50	244	HMC3081S188	○
18,90	20	168	190	50	244	HMC3081S189	○
19,00	20	168	190	50	244	HMC3081S190	○
19,10	20	168	190	50	244	HMC3081S191	○
19,20	20	168	190	50	244	HMC3081S192	○
19,30	20	168	190	50	244	HMC3081S193	○
19,40	20	168	190	50	244	HMC3081S194	○
19,50	20	168	190	50	244	HMC3081S195	○
19,60	20	168	190	50	244	HMC3081S196	○
19,70	20	168	190	50	244	HMC3081S197	○
19,80	20	168	190	50	244	HMC3081S198	○
19,90	20	168	190	50	244	HMC3081S199	○
20,00	20	168	190	50	244	HMC3081S200	○

Notes

PUNTE HM PER ALLUMINIO FINO 25xD

HM DRILLS FOR ALU UP TO 25xD / HM-BOHRER FÜR ALU BIS 25xD /
FORETS HM POUR ALU JUSQU'À 25xD

3051N

Punta 5xD con fori
5xD Drill with internal coolant
5xD Bohrer mit IK
5xD Foret avec trous de lubrification



Silmax
NORM

DIN
6535 HA
(Standard)



N

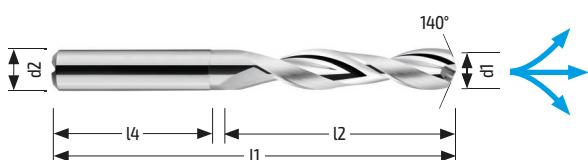

140°	d1 m7	d2 h6	lu	l2	l4	l1	Uncoated	Stock
	3,00	6	23	28	36	66	HM03051N030	●
	3,20	6	23	28	36	66	HM03051N032	●
	3,30	6	23	28	36	66	HM03051N033	●
	3,50	6	23	28	36	66	HM03051N035	●
	3,70	6	23	28	36	66	HM03051N037	●
	3,90	6	29	36	36	74	HM03051N039	●
	4,00	6	29	36	36	74	HM03051N040	●
	4,10	6	29	36	36	74	HM03051N041	●
	4,20	6	29	36	36	74	HM03051N042	●
	4,30	6	29	36	36	74	HM03051N043	●
	4,50	6	29	36	36	74	HM03051N045	●
	4,60	6	29	36	36	74	HM03051N046	●
	4,70	6	29	36	36	74	HM03051N047	●
	5,00	6	35	44	36	82	HM03051N050	●
	5,10	6	35	44	36	82	HM03051N051	●
	5,20	6	35	44	36	82	HM03051N052	●
	5,50	6	35	44	36	82	HM03051N055	●
	5,60	6	35	44	36	82	HM03051N056	●
	6,00	6	35	44	36	82	HM03051N060	●
	6,10	8	43	53	36	91	HM03051N061	●
	6,20	8	43	53	36	91	HM03051N062	●
	6,30	8	43	53	36	91	HM03051N063	●
	6,40	8	43	53	36	91	HM03051N064	●
	6,50	8	43	53	36	91	HM03051N065	●
	6,60	8	43	53	36	91	HM03051N066	●
	6,80	8	43	53	36	91	HM03051N068	●

P

Acciaio
Steel
Stahl
Acier

H

Acciaio Temprato
Hardened Steel
Gehärteter Stahl
Acier trempé

K

Ghisa
Cast Iron
Gusseisen
Fonte

M

Acciaio Inox
Stainless Steel
Edelstahl
Acier Inoxydable

S

HRSA - Titanio
HRSA - Titanium
HRSA - Titan
HRSA - Titane

N

Metalli non ferrosi
Non-ferrous metals
NE-Metalle
Matières non ferreuses

O

NON ISO
Not ISO
Keine ISO
Pas d'ISO

● Disponibilità pronta consegna
Availability for prompt delivery

● Consegna 5 giorni data ordine
Delivery 5 days order date

○ Disponibilità su richiesta
Availability on request

140°

d1 m7	d2 h6	lu	l2	l4	l1	Uncoated	Stock
7,00	8	43	53	36	91	HM03051N070	●
7,40	8	43	53	36	91	HM03051N074	●
7,50	8	43	53	36	91	HM03051N075	●
7,60	8	43	53	36	91	HM03051N076	●
8,00	8	43	53	36	91	HM03051N080	●
8,40	10	49	61	40	103	HM03051N084	●
8,50	10	49	61	40	103	HM03051N085	●
8,73	10	49	61	40	103	HM03051N087	●
8,90	10	49	61	40	103	HM03051N089	●
9,00	10	49	61	40	103	HM03051N090	●
9,20	10	49	61	40	103	HM03051N092	●
9,30	10	49	61	40	103	HM03051N093	●
9,50	10	49	61	40	103	HM03051N095	●
9,60	10	49	61	40	103	HM03051N096	●
10,00	10	49	61	40	103	HM03051N100	●
10,20	12	56	71	45	118	HM03051N102	●
10,50	12	56	71	45	118	HM03051N105	●
10,80	12	56	71	45	118	HM03051N108	●
11,00	12	56	71	45	118	HM03051N110	●
11,50	12	56	71	45	118	HM03051N115	●
12,00	12	56	71	45	118	HM03051N120	●
12,50	14	60	77	45	124	HM03051N125	●
13,50	14	60	77	45	124	HM03051N135	●
14,00	14	60	77	45	124	HM03051N140	●
16,00	16	63	83	48	133	HM03051N160	●
20,00	20	77	101	50	153	HM03051N200	●

Notes

3151N

Punta 15xD con fori
 15xD Drill with internal coolant
 15xD Bohrer mit IK
 15xD Foret avec trous de lubrification



DIN
6537L

DIN
6535 HA
(Standard)



N

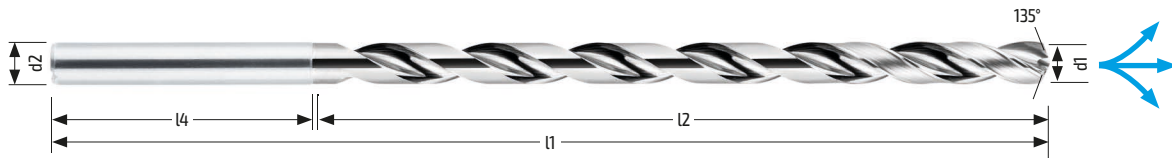

135°

d1 h7	d2 h6	l4	l2	l1	Uncoated	Stock	
3,00	4	52	56	32	90	HM03151N030	●
3,50	4	61	66	32	100	HM03151N035	●
4,00	4	60	66	32	100	HM03151N040	●
5,00	5	77	84	34	120	HM03151N050	●
6,00	6	93	102	36	140	HM03151N060	●
7,00	7	105	115	38	155	HM03151N070	●
8,00	8	121	133	40	175	HM03151N080	●
10,00	10	153	168	40	210	HM03151N100	●
12,00	12	185	203	45	250	HM03151N120	●

P

Acciaio
Steel
Stahl
Acier

H

Acciaio Temprato
Hardened Steel
Gehärteter Stahl
Acier trempé

K

Ghisa
Cast Iron
Gusseisen
Fonte

M

Acciaio Inox
Stainless Steel
Edelstahl
Acier Inoxydable

S

HRSA - Titanio
HRSA - Titanium
HRSA - Titan
HRSA - Titane

N

Metalli non ferrosi
Non-ferrous metals
NE-Metalle
Matières non ferreuses

O

NON ISO
Not ISO
Keine ISO
Pas d'ISO

● **Disponibilità pronta consegna**
Availability for prompt delivery

● **Consegna 5 giorni data ordine**
Delivery 5 days order date

○ **Disponibilità su richiesta**
Availability on request

3201N

Punta 20xD con fori
20xD Drill with internal coolant
20xD Bohrer mit IK
20xD Foret avec trous de lubrification



DIN
6537L

DIN
6535 HA
(Standard)



N



135°	d1 h7	d2 h6	lu	l2	l4	l1	Uncoated	Stock
	3,00	4	70	74	32	110	HM03201N030	●
	4,00	4	80	86	32	120	HM03201N040	●
	5,00	5	102	109	34	145	HM03201N050	●
	5,50	6	112	120	36	160	HM03201N055	●
	6,00	6	121	130	36	170	HM03201N060	●
	7,00	7	140	150	38	190	HM03201N070	●
	8,00	8	161	173	40	215	HM03201N080	●
	10,00	10	203	218	40	260	HM03201N100	●
	12,00	12	240	258	45	305	HM03201N120	●

3251N

Punta 25xD con fori
25xD Drill with internal coolant
25xD Bohrer mit IK
25xD Foret avec trous de lubrification



DIN
6537L

DIN
6535 HA
(Standard)



N



135°	d1 h7	d2	lu	l2	l4	l1	Uncoated	Stock
	3,00	4	87	91	32	125	HM03251N030	●
	4,00	4	100	106	32	140	HM03251N040	●
	5,00	5	127	134	34	170	HM03251N050	●
	6,00	6	151	160	36	200	HM03251N060	●
	7,00	7	175	185	38	225	HM03251N070	●
	8,00	8	201	213	40	255	HM03251N080	●
	10,00	10	253	268	40	310	HM03251N100	●

PUNTE A GRADINO

STEP DRILLS / STUFENBOHRER / FORETS ÉTAGÉS

3825

Punta 2.5xD con fori
 2.5xD Drill with internal coolant
 2.5xD Bohrer mit IK
 2.5xD Foret avec trous de lubrification



Silmax
NORM

λ 30°

2,5d1

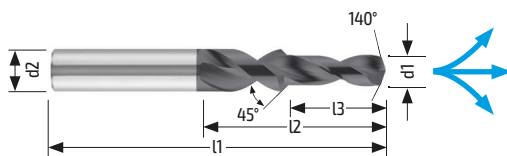

140°

FIL ISO	FIL UNC	d1 m7	d2 h6	l3	l2	l1	X-Pro Coating	Stock
M4	-	3,30	6	10	23	64	HMX382510330	●
M4*	-	3,40	6	10	23	64	HMX382510340	●
M5	-	4,20	6	13	26	64	HMX382510420	●
M5*	-	4,30	6	13	26	64	HMX382510430	●
M6	-	5,00	8	15	32	74	HMX382510500	●
M6*	1/4 - 20	5,10	8	15	32	74	HMX382510510	●
M8	-	6,80	10	20	42	90	HMX382510680	●
M8*	-	6,90	10	20	42	90	HMX382510690	●
-	3/8 - 16	7,90	12	24	50	105	HMX382510790	●
M10	-	8,50	12	25	51	105	HMX382510850	●
M10*	-	8,65	12	25	51	105	HMX382510865	●
M12	-	10,25	14	30	60	107	HMX382511025	●
M12*	-	10,40	14	30	60	107	HMX382511040	●
-	1/2 - 13	10,50	14	32	62	120	HMX382511050	●

P

Acciaio
Steel
Stahl
Acier

H

Acciaio Temprato
Hardened Steel
Gehärteter Stahl
Acier trempé

K

Ghisa
Cast Iron
Gusseisen
Fonte

M

Acciaio Inox
Stainless Steel
Edelstahl
Acier Inoxydable

S

HRSA - Titanio
HRSA - Titanium
HRSA - Titan
HRSA - Titane

N

Metalli non ferrosi
Non-ferrous metals
NE-Metalle
Matières non ferreuses

O

NON ISO
Not ISO
Keine ISO
Pas d'ISO

● Disponibilità pronta consegna Available for prompt delivery

● Consegna 5 giorni data ordine Delivery 5 days order date

3835

Punta 3.5xD con fori
3.5xD Drill with internal coolant
3.5xD Bohrer mit IK
3.5xD Foret avec trous de lubrification

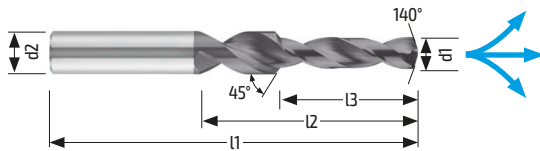
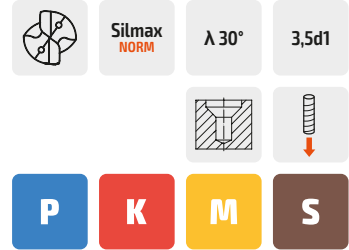

140°	FIL ISO	FIL UNC	d1 m7	d2 h6	l3	l2	l1	X-Pro Coating	Stock
	M4	-	3,30	6	14	27	64	HMX383510330	●
	M4*	-	3,40	6	14	27	64	HMX383510340	●
	M5	-	4,20	6	18	31	68	HMX383510420	●
	M5*	-	4,30	6	18	31	68	HMX383510430	●
	M6	-	5,00	8	21	38	78	HMX383510500	●
	M6*	1/4 - 20	5,10	8	21	38	78	HMX383510510	●
	M8	-	6,80	10	28	50	98	HMX383510680	●
	M8*	-	6,90	10	28	50	98	HMX383510690	●
	-	3/8 - 16	7,90	12	34	60	107	HMX383510790	●
	M10	-	8,50	12	35	61	107	HMX383510850	●
	M10*	-	8,65	12	35	61	107	HMX383510865	●
	M12	-	10,25	14	42	72	120	HMX383511025	●
	M12*	-	10,40	14	42	72	120	HMX383511040	●
	-	1/2 - 13	10,50	14	45	75	127	HMX383511050	●

P

Acciaio
Steel
Stahl
Acier

H

Acciaio Temprato
Hardened Steel
Gehärteter Stahl
Acier trempé

K

Ghisa
Cast Iron
Gusseisen
Fonte

M

Acciaio Inox
Stainless Steel
Edelstahl
Acier Inoxydable

S

HRSA - Titanio
HRSA - Titanium
HRSA - Titan
HRSA - Titane

N

Metalli non ferrosi
Non-ferrous metals
NE-Metalle
Matières non ferreuses

O

NON ISO
Not ISO
Keine ISO
Pas d'ISO

● **Disponibilità pronta consegna** Available for prompt delivery

● **Consegna 5 giorni data ordine** Delivery 5 days order date

PUNTE A CENTRARE

CENTER DRILLS / ZENTRIERBOHRUNGEN / FORETS À CENTRER

351

Punte a centrare 118°
Center Drills 118°
Zentrierbohrer 118°
Forets à centrer 118°



Form A

DIN
333A

P

K

M

S

N

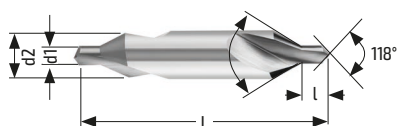

118°	d1 k12	d2 h6	L	l ap	Uncoated	Stock	Balinit® Alcrona Coating	Stock
	1,00	3,15	31	1,3-1,6	HMO351100	●	HMG351100	●
	1,25	3,15	31	1,6-1,9	HMO351125	●	HMG351125	●
	1,60	4,00	35	2,0-2,4	HMO351160	●	HMG351160	●
	2,00	5,00	40	2,5-2,9	HMO351200	●	HMG351200	●
	2,50	6,30	45	3,1-3,6	HMO351250	●	HMG351250	●
	3,15	8,00	50	3,9-4,4	HMO351315	●	HMG351315	●
	4,00	10,00	55	5,0-5,6	HMO351400	●	HMG351400	●
	5,00	12,50	63	6,3-6,9	HMO351500	●	HMG351500	●

P

Acciaio
Steel
Stahl
Acier

H

Acciaio Temprato
Hardened Steel
Gehärteter Stahl
Acier trempé

K

Ghisa
Cast Iron
Gusseisen
Fonte

M

Acciaio Inox
Stainless Steel
Edelstahl
Acier Inoxydable

S

HRSA - Titanio
HRSA - Titanium
HRSA - Titan
HRSA - Titane

N

Metalli non ferrosi
Non-ferrous metals
NE-Metalle
Matières non ferreuses

O

NON ISO
Not ISO
Keine ISO
Pas d'ISO

● Disponibilità pronta consegna
Availability for prompt delivery

● Consegna 5 giorni data ordine
Delivery 5 days order date

○ Disponibilità su richiesta
Availability on request

357

Punte a centrare 90°
Center Drills 90°
Zentrierbohrer 90°
Forets à centrer 90°

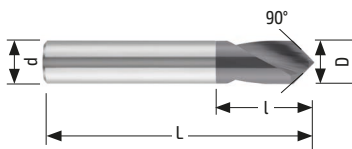

90°	D h6	L	l ap	Uncoated	Stock	Balinit® Alcrona Coating	Stock
	3,00	45	10,0	HM0357003	●	HMG357003	●
	4,00	50	12,0	HM0357004	●	HMG357004	●
	5,00	50	15,0	HM0357005	●	HMG357005	●
	6,00	50	18,0	HM0357006	●	HMG357006	●
	8,00	64	23,0	HM0357008	●	HMG357008	●
	10,00	67	24,0	HM0357010	●	HMG357010	●
	12,00	74	24,0	HM0357012	●	HMG357012	●
	16,00	92	32,0	HM0357016	●	HMG357016	●

P
Acciaio
Steel
Stahl
Acier

H
Acciaio Temprato
Hardened Steel
Gehärteter Stahl
Acier trempé

K
Ghisa
Cast Iron
Gusseisen
Fonte

M
Acciaio Inox
Stainless Steel
Edelstahl
Acier Inoxydable

S
HRSA - Titanio
HRSA - Titanium
HRSA - Titan
HRSA - Titane

N
Metalli non ferrosi
Non-ferrous metals
NE-Metalle
Matières non ferreuses

O
NON ISO
Not ISO
Keine ISO
Pas d'ISO

● **Disponibilità pronta consegna**
Availability for prompt delivery

● **Consegna 5 giorni data ordine**
Delivery 5 days order date

○ **Disponibilità su richiesta**
Availability on request

358

Punte a centrare 120°
Center Drills 120°
Zentrierbohrer 120°
Forets à centrer 120*

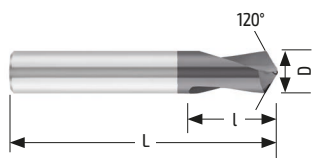

120°	D h6	L	l ap	Uncoated	Stock	Balinit® Alcrona Coating	Stock
	3,00	45	10,0	HM0358003	●	HMG358003	●
	4,00	50	12,0	HM0358004	●	HMG358004	●
	5,00	50	15,0	HM0358005	●	HMG358005	●
	6,00	50	18,0	HM0358006	●	HMG358006	●
	8,00	64	23,0	HM0358008	●	HMG358008	●
	10,00	67	24,0	HM0358010	●	HMG358010	●
	12,00	74	24,0	HM0358012	●	HMG358012	●

P

Acciaio
Steel
Stahl
Acier

H

Acciaio Temprato
Hardened Steel
Gehärteter Stahl
Acier trempé

K

Ghisa
Cast Iron
Gusseisen
Fonte

M

Acciaio Inox
Stainless Steel
Edelstahl
Acier Inoxydable

S

HRSA - Titanio
HRSA - Titanium
HRSA - Titan
HRSA - Titane

N

Metalli non ferrosi
Non-ferrous metals
NE-Metalle
Matières non ferreuses

O

NON ISO
Not ISO
Keine ISO
Pas d'ISO

● **Disponibilità pronta consegna**
Availability for prompt delivery

● **Consegna 5 giorni data ordine**
Delivery 5 days order date

○ **Disponibilità su richiesta**
Availability on request

ALESATORI CENTESIMALI

REAMERS / HUNDERTSTEL - REIBAHLEN / ALÉSOIRS CENTÉSIMALES

Scelta dell'alesatore / Choice of the ream / Auswahl vom Reibahlen / Choix de l'alesoir

Toll.	D. 2 mm	D. 3 mm	D. 4 mm	D. 5 mm	D. 6 mm	D. 8 mm	D. 10 mm	D. 12 mm
D10	2,04	3,04	4,05	5,06	6,06	8,07	10,08	12,10
E8	2,02	3,02	4,03	5,03	6,03	8,03	10,03	12,04
E9	2,03	3,03	4,04	5,04	6,04	8,05	10,05	12,06
F7	2,01	3,01	4,01	5,01	6,01	8,02	10,02	12,02
F8	2,01	3,01	4,02	5,02	6,02	8,02	10,02	12,03
G7	-	-	-	-	-	8,01	10,01	12,01
H6	2,00	3,00	4,00	5,00	6,00	8,00	10,00	12,00
H7	-	-	-	-	-	-	-	-
H8	-	-	4,01	5,01	6,01	8,01	10,01	12,01
H9	2,01	3,01	4,02	5,02	6,02	8,02	10,02	12,03
M7	1,99	2,99	3,99	4,99	5,99	7,99	9,99	11,99
N7	1,99	2,99	3,99	4,99	5,99	7,98	9,98	11,98
P7	1,99	2,99	3,98	4,98	5,98	7,98	9,98	11,97
R7	1,98	2,98	3,98	4,98	5,98	7,98	9,98	11,97

Esempio / Example / Beispiel / Exemple

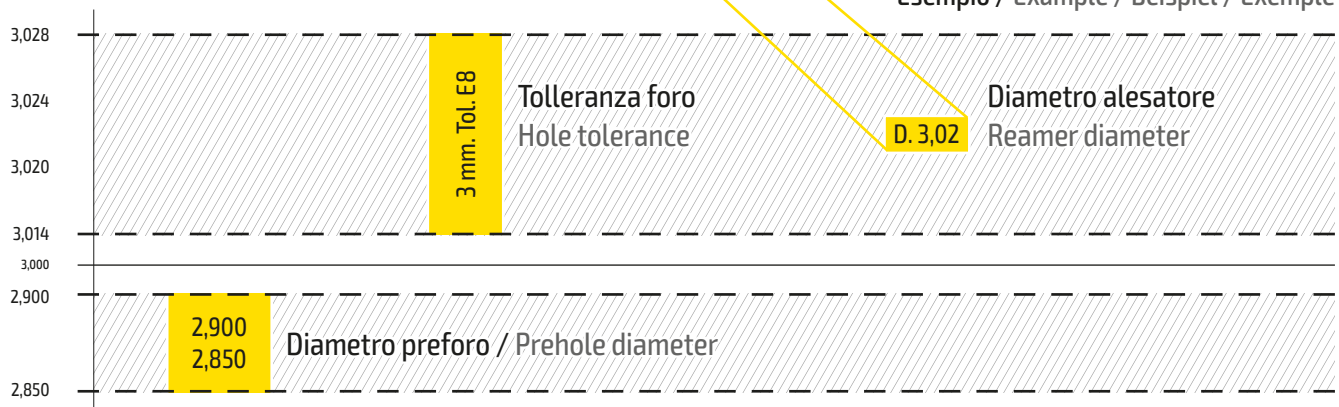

		P	M	K	N	S	H				
		Acciaio Steel <800 N/mm ²	Acciaio Steel <1000 N/mm ²	Acciaio Steel <1300 N/mm ²	Acciaio Inox Stainless Steel	Ghisa Cast Iron	Metalli non ferrosi Non-ferrous metals	HRSA - Titanio HRSA - Titanium	Acciaio Temprato Hardened Steel		
		Vc m/min	20-25	12-18	10-15	7-12	8-10	40-60	6-10	7-12	6-10
Ø	0,9-2	fg mm/g	0,10	0,08	0,08	0,07	0,07	0,15	0,07	0,07	0,07
	2-6		0,12	0,10	0,09	0,08	0,08	0,18	0,10	0,08	0,10
	6-10		0,18	0,15	0,14	0,12	0,12	0,25	0,12	0,12	0,12
	10-16		0,18	0,20	0,18	0,15	0,15	0,30	0,15	0,15	0,15

Come ordinare (esempio)

How to order (example)

Rivestimento

Coating

HMG

Codice

Code

503

Diametro

Diameter

0403 (= 4,03mm)

Codice per ordine

Code to place order

HMG5030403

502

Alesatori centesimali extracorti
Extra-short reamers
Extra kurze Hundertstel-Reibahle
Alésours au centième extra-courts

DIN
8089λ 6°
LH

d1 -0/+0,004	d2 h8	l2	l1	Uncoated	Stock	Balinit® Alcrona Coating	Stock
2,97 - 3,10	3,00	16	56	HM0502...	●	HMG502...	●
3,11 - 3,60	3,00	18	56	HM0502...	●	HMG502...	●
3,61 - 4,10	3,50	20	56	HM0502...	●	HMG502...	●
4,11 - 4,60	4,00	22	63	HM0502...	●	HMG502...	●
4,61 - 5,10	4,00	22	63	HM0502...	●	HMG502...	●
5,11 - 5,60	5,00	22	63	HM0502...	●	HMG502...	●
5,61 - 6,15	5,00	22	63	HM0502...	●	HMG502...	●
6,16 - 6,65	5,00	22	63	HM0502...	●	HMG502...	●
6,66 - 7,15	6,00	25	71	HM0502...	●	HMG502...	●
7,16 - 7,65	6,00	25	71	HM0502...	●	HMG502...	●
7,66 - 8,15	6,00	25	71	HM0502...	●	HMG502...	●
8,16 - 8,65	6,00	25	71	HM0502...	●	HMG502...	●
8,66 - 9,20	8,00	25	71	HM0502...	●	HMG502...	●
9,21 - 9,70	8,00	25	71	HM0502...	●	HMG502...	●
9,71 - 10,20	8,00	25	71	HM0502...	●	HMG502...	●
10,21 - 10,70	8,00	28	80	HM0502...	●	HMG502...	●
10,71 - 11,20	10,00	28	80	HM0502...	●	HMG502...	●
11,21 - 11,70	10,00	28	80	HM0502...	●	HMG502...	●
11,71 - 12,20	10,00	28	80	HM0502...	●	HMG502...	●
12,21 - 13,20	10,00	28	80	HM0502...	●	HMG502...	●
13,21 - 14,20	12,00	32	90	HM0502...	●	HMG502...	●
14,21 - 15,20	12,00	32	90	HM0502...	●	HMG502...	●
15,21 - 16,20	14,00	32	90	HM0502...	●	HMG502...	●
16,21 - 17,20	14,00	32	90	HM0502...	●	HMG502...	●
17,21 - 18,20	16,00	36	100	HM0502...	●	HMG502...	●

P

Acciaio
Steel
Stahl
Acier

H

Acciaio Temprato
Hardened Steel
Gehärteter Stahl
Acier trempé

K

Ghisa
Cast Iron
Gusseisen
Fonte

M

Acciaio Inox
Stainless Steel
Edelstahl
Acier Inoxydable

S

HRSA - Titanio
HRSA - Titanium
HRSA - Titan
HRSA - Titane

N

Metalli non ferrosi
Non-ferrous metals
NE-Metalle
Matières non ferreuses

O

NON ISO
Not ISO
Keine ISO
Pas d'ISO

● Disponibilità pronta consegna
Availability for prompt delivery

⦿ Consegna 5 giorni data ordine
Delivery 5 days order date

○ Disponibilità su richiesta
Availability on request

503

Alesatori centesimali standard
Standard reamers
Standard Hundertstel-Reibahle
Alésoirs au centième standards

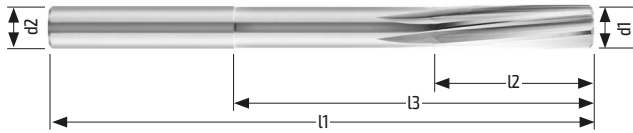
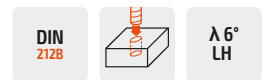

d1 -0 / +0,004	d2 h8	l3	l2	l1	Uncoated	Stock	Balinit® Alcrona Coating	Stock
0,90 - 0,99	-	8	-	40	HM0503...	●	HMG503...	-
1,00 - 1,50	-	8	-	40	HM0503...	●	HMG503...	●
1,51 - 1,90	-	9	-	43	HM0503...	●	HMG503...	●
1,91 - 2,12	2	11	26	49	HM0503...	●	HMG503...	●
2,13 - 2,36	2	12	-	53	HM0503...	●	HMG503...	●
2,37 - 2,48	2	14	-	57	HM0503...	●	HMG503...	●
2,49 - 2,65	3	14	-	57	HM0503...	●	HMG503...	●
2,66 - 2,96	3	16	40	65	HM0503...	●	HMG503...	●
2,97 - 2,99	3	16	40	65	HM0503...	●	HMG503...	●
3,03 - 3,35	3	16	40	65	HM0503...	●	HMG503...	●
3,36 - 3,49	4	18	45	70	HM0503...	●	HMG503...	●
3,51 - 3,75	4	18	45	70	HM0503...	●	HMG503...	●
3,76 - 3,99	4	19	47	75	HM0503...	●	HMG503...	●
4,01 - 4,25	4	19	47	75	HM0503...	●	HMG503...	●
4,26 - 4,75	5	21	51	80	HM0503...	●	HMG503...	●
4,76 - 4,99	5	23	56	86	HM0503...	●	HMG503...	●
4,51 - 4,99	5	23	56	86	HM0503...	●	HMG503...	●
5,03 - 5,15	5	23	56	86	HM0503...	●	HMG503...	●
5,16 - 5,49	5	26	58	93	HM0503...	●	HMG503...	●
5,51 - 5,65	5	26	58	93	HM0503...	●	HMG503...	●
5,66 - 5,99	6	26	58	93	HM0503...	●	HMG503...	●
6,03 - 6,15	6	26	58	93	HM0503...	●	HMG503...	●
6,16 - 6,49	6	28	63	101	HM0503...	●	HMG503...	●
6,51 - 6,70	6	28	63	101	HM0503...	●	HMG503...	●
6,71 - 7,65	7	31	71	109	HM0503...	●	HMG503...	●
7,66 - 7,99	8	33	77	117	HM0503...	●	HMG503...	●
8,03 - 8,49	8	33	77	117	HM0503...	●	HMG503...	●
8,51 - 8,65	8	33	77	117	HM0503...	●	HMG503...	●
8,66 - 9,65	9	36	80	125	HM0503...	●	HMG503...	●
9,66 - 9,99	10	38	85	133	HM0503...	●	HMG503...	●
10,03 - 10,65	10	38	85	133	HM0503...	●	HMG503...	●
10,66 - 11,65	10	41	92	142	HM0503...	●	HMG503...	●
11,66 - 11,99	12	44	99	151	HM0503...	●	HMG503...	●
12,03 - 12,20	12	44	99	151	HM0503...	●	HMG503...	●

P

Acciaio
Steel
Stahl
Acier

H

Acciaio Temprato
Hardened Steel
Gehärteter Stahl
Acier trempé

K

Ghisa
Cast Iron
Gusseisen
Fonte

M

Acciaio Inox
Stainless Steel
Edelstahl
Acier Inoxydable

S

HRSA - Titanio
HRSA - Titanium
HRSA - Titan
HRSA - Titane

N

Metalli non ferrosi
Non-ferrous metals
NE-Metalle
Matières non ferreuses

O

NON ISO
Not ISO
Keine ISO
Pas d'ISO

● Disponibilità pronta consegna
Availability for prompt delivery

● Consegna 5 giorni data ordine
Delivery 5 days order date

○ Disponibilità su richiesta
Availability on request

d1 -0/+0,004	d2 h8	l3	l2	l1	Uncoated	Stock	Balinit® Alcrona Coating	Stock
12,21 - 13,65	12	44	99	151	HM0503...	●	HMG503...	●
13,66 - 14,20	14	47	105	160	HM0503...	●	HMG503...	●
14,21 - 15,65	14	50	107	162	HM0503...	●	HMG503...	●
15,66 - 16,20	16	52	115	170	HM0503...	●	HMG503...	●
16,21 - 17,20	16	52	115	170	HM0503...	●	HMG503...	●
17,21 - 18,20	16	52	115	170	HM0503...	●	HMG503...	●
18,21 - 19,20	18	52	115	170	HM0503...	●	HMG503...	●
19,21 - 20,20	20	52	115	170	HM0503...	●	HMG503...	●

d1 -0/+0,004	d2 h8	l3	l2	l1	Uncoated	Stock	Balinit® Alcrona Coating	Stock
3,00	3	16	40	65	HM05030300	●	HMG5030300	●
3,01	3	16	40	65	HM05030301	●	HMG5030301	●
3,02	3	16	40	65	HM05030302	●	HMG5030302	●
3,50	4	18	45	70	HM05030350	●	HMG5030350	●
4,00	4	19	47	75	HM05030400	●	HMG5030400	●
4,01	4	19	47	75	HM05030401	●	HMG5030401	●
4,02	4	19	47	75	HM05030402	●	HMG5030402	●
4,50	5	23	56	86	HM05030450	●	HMG5030450	●
5,00	5	23	56	86	HM05030500	●	HMG5030500	●
5,01	5	23	56	86	HM05030501	●	HMG5030501	●
5,02	5	23	56	86	HM05030502	●	HMG5030502	●
5,50	5	26	58	93	HM05030550	●	HMG5030550	●
6,00	6	26	58	93	HM05030600	●	HMG5030600	●
6,01	6	26	58	93	HM05030601	●	HMG5030601	●
6,02	6	26	58	93	HM05030602	●	HMG5030602	●
6,50	6	28	63	101	HM05030650	●	HMG5030650	●
8,00	8	33	77	117	HM05030800	●	HMG5030800	●
8,01	8	33	77	117	HM05030801	●	HMG5030801	●
8,02	8	33	77	117	HM05030802	●	HMG5030802	●
8,50	8	33	77	117	HM05030850	●	HMG5030850	●
10,00	10	38	85	133	HM05031000	●	HMG5031000	●
10,01	10	38	85	133	HM05031001	●	HMG5031001	●
10,02	10	38	85	133	HM05031002	●	HMG5031002	●
12,00	12	44	99	151	HM05031200	●	HMG5031200	●
12,01	12	44	99	151	HM05031201	●	HMG5031201	●
12,02	12	44	99	151	HM05031202	●	HMG5031202	●

504

Alesatori centesimali extralunghi
Extra-long reamers
Extra lange Hundertstel-Reibahle
Alésoirs au centième extra-longi

λ 6°
LH

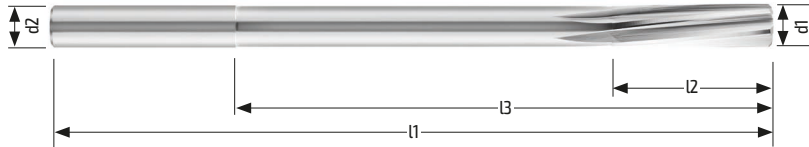

d1 -0 / +0,004	d2 h8	l3	l2	l1	Uncoated	Stock	Balinit® Alcrona Coating	Stock
2,00 - 2,31	2,00	18	65	110	HMG504...	●	HMG504...	●
2,32 - 2,41	2,30	20	65	120	HMG504...	●	HMG504...	●
2,42 - 2,91	2,50	20	65	120	HMG504...	●	HMG504...	●
2,92 - 3,11	3,00	20	65	120	HMG504...	●	HMG504...	●
3,12 - 3,31	3,00	30	90	150	HMG504...	●	HMG504...	●
3,32 - 3,91	3,50	30	90	150	HMG504...	●	HMG504...	●
3,92 - 3,99	4,00	30	90	150	HMG504...	●	HMG504...	●
4,01 - 4,24	4,00	30	90	150	HMG504...	●	HMG504...	●
4,25 - 4,91	4,00	35	115	180	HMG504...	●	HMG504...	●
4,92 - 4,99	5,00	35	115	180	HMG504...	●	HMG504...	●
5,01 - 5,11	5,00	35	115	180	HMG504...	●	HMG504...	●
5,12 - 5,91	5,00	40	130	200	HMG504...	●	HMG504...	●
5,92 - 5,99	6,00	40	130	200	HMG504...	●	HMG504...	●
6,01 - 6,11	6,00	40	130	200	HMG504...	●	HMG504...	●
6,12 - 6,91	6,00	45	130	200	HMG504...	●	HMG504...	●
6,92 - 7,11	7,00	45	130	200	HMG504...	●	HMG504...	●
7,12 - 7,91	7,00	45	130	200	HMG504...	●	HMG504...	●
7,92 - 7,99	8,00	45	130	200	HMG504...	●	HMG504...	●
8,01 - 8,11	8,00	45	130	200	HMG504...	●	HMG504...	●
8,12 - 8,91	8,00	5	145	220	HMG504...	●	HMG504...	●
8,92 - 9,11	9,00	50	145	220	HMG504...	●	HMG504...	●
9,12 - 9,91	9,00	50	145	220	HMG504...	●	HMG504...	●
9,92 - 9,99	10,00	50	145	220	HMG504...	●	HMG504...	●
10,01 - 10,20	10,00	50	145	220	HMG504...	●	HMG504...	●
10,21 - 10,80	10,00	55	170	250	HMG504...	●	HMG504...	●
10,81 - 11,20	11,00	55	170	250	HMG504...	●	HMG504...	●
11,21 - 11,80	11,00	55	170	250	HMG504...	●	HMG504...	●
11,81 - 11,99	12,00	55	170	250	HMG504...	●	HMG504...	●
12,01 - 12,20	12,00	55	170	250	HMG504...	●	HMG504...	●

P

Acciaio
Steel
Stahl
Acier

H

Acciaio Temprato
Hardened Steel
Gehärteter Stahl
Acier trempé

K

Ghisa
Cast Iron
Gusseisen
Fonte

M

Acciaio Inox
Stainless Steel
Edelstahl
Acier Inoxydable

S

HRSA - Titanio
HRSA - Titanium
HRSA - Titan
HRSA - Titane

N

Metalli non ferrosi
Non-ferrous metals
NE-Metalle
Matières non ferreuses

O

NON ISO
Not ISO
Keine ISO
Pas d'ISO

● Disponibilità pronta consegna
Availability for prompt delivery

⦿ Consegna 5 giorni data ordine
Delivery 5 days order date

○ Disponibilità su richiesta
Availability on request

d1 -0/+0,004	d2 h8	l3	l2	l1	Uncoated	Stock	Balinit® Alcrona Coating	Stock
4,00	4	30	90	150	HM05040400	●	HMG5040400	●
5,00	5	35	115	180	HM05040500	●	HMG5040500	●
6,00	6	40	130	200	HM05040600	●	HMG5040600	●
8,00	8	45	130	200	HM05040800	●	HMG5040800	●
10,00	10	50	145	220	HM05041000	●	HMG5041000	●
12,00	12	55	170	250	HM05041200	●	HMG5041200	●

Notes

3030A-3050A

Parametri di lavoro/Working Parameters/
Bearbeitungsparameter/Paramètres d'usinage

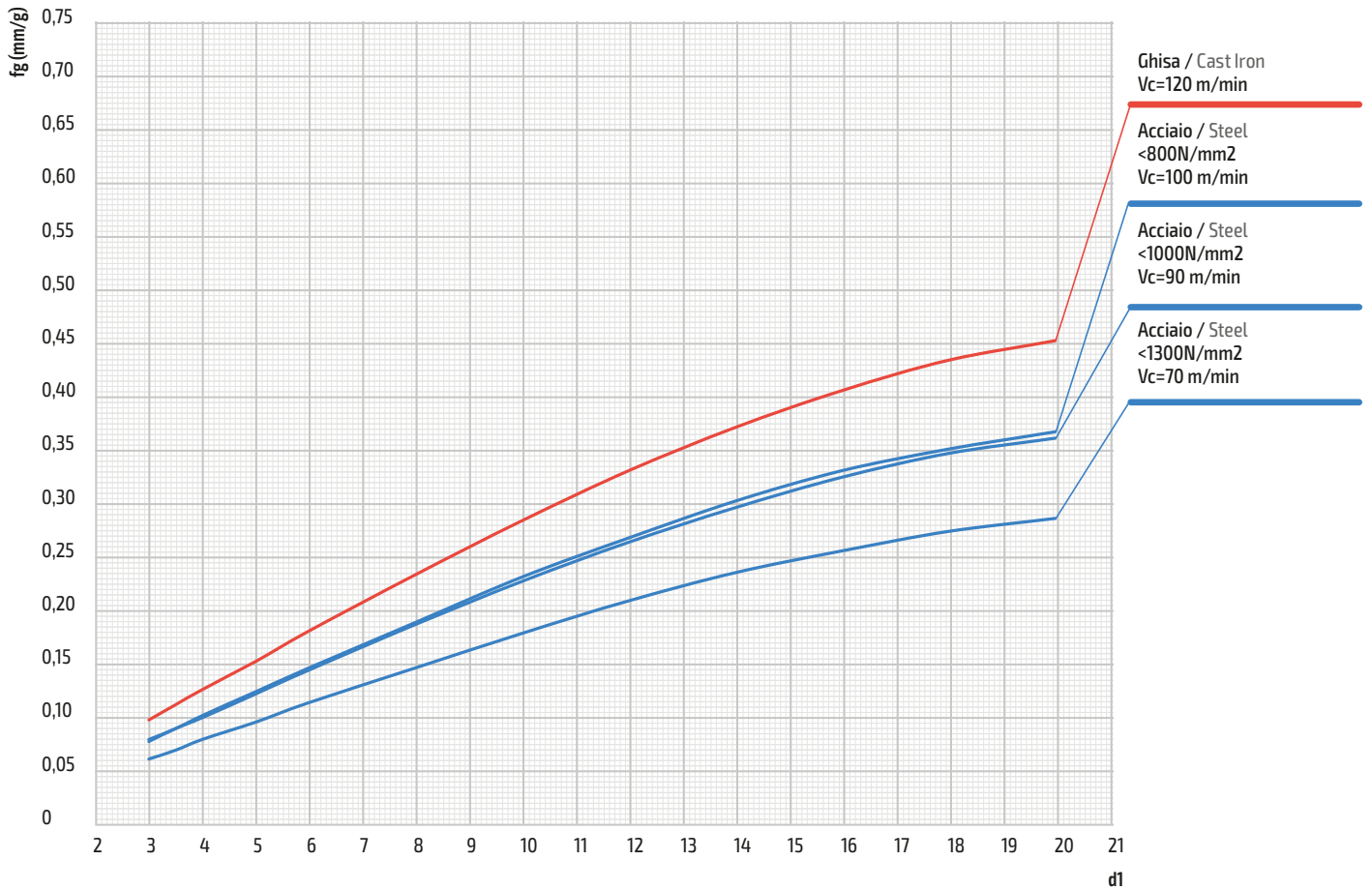

P

Acciaio
Steel
Stahl
Acier

H

Acciaio Temprato
Hardened Steel
Gehärteter Stahl
Acier trempé

K

Ghisa
Cast Iron
Gusseisen
Fonte

M

Acciaio Inox
Stainless Steel
Edelstahl
Acier Inoxydable

S

HRSA - Titanio
HRSA - Titanium
HRSA - Titan
HRSA - Titane

N

Metalli non ferrosi
Non-ferrous metals
NE-Metalle
Matières non ferreuses

O

NON ISO
Not ISO
Keine ISO
Pas d'ISO

3031A-3051A

Parametri di lavoro/Working Parameters/ Bearbeitungsparameter/Paramètres d'usinage

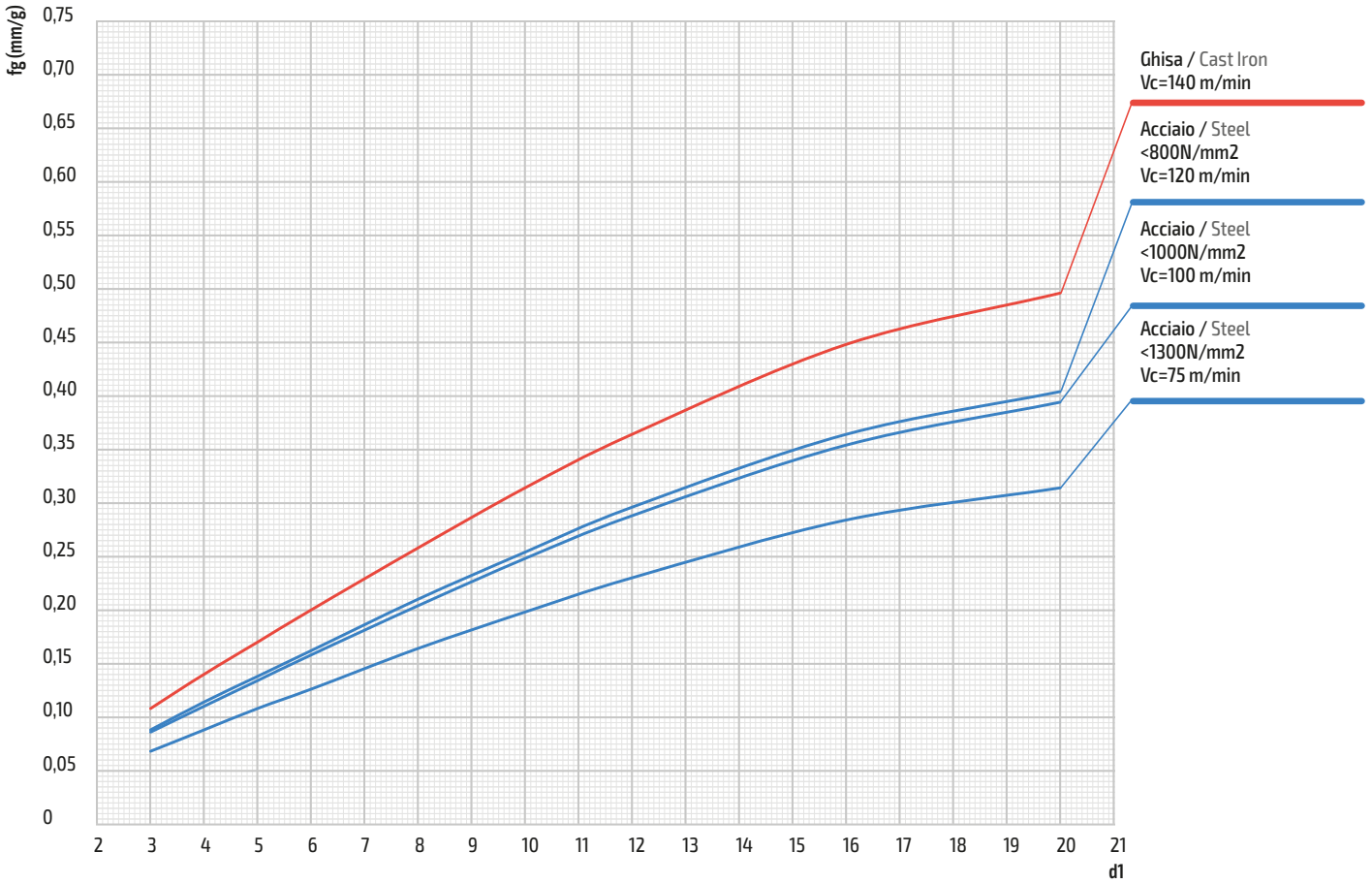

3081A-3121A

Parametri di lavoro/Working Parameters/
Bearbeitungsparameter/Paramètres d'usinage

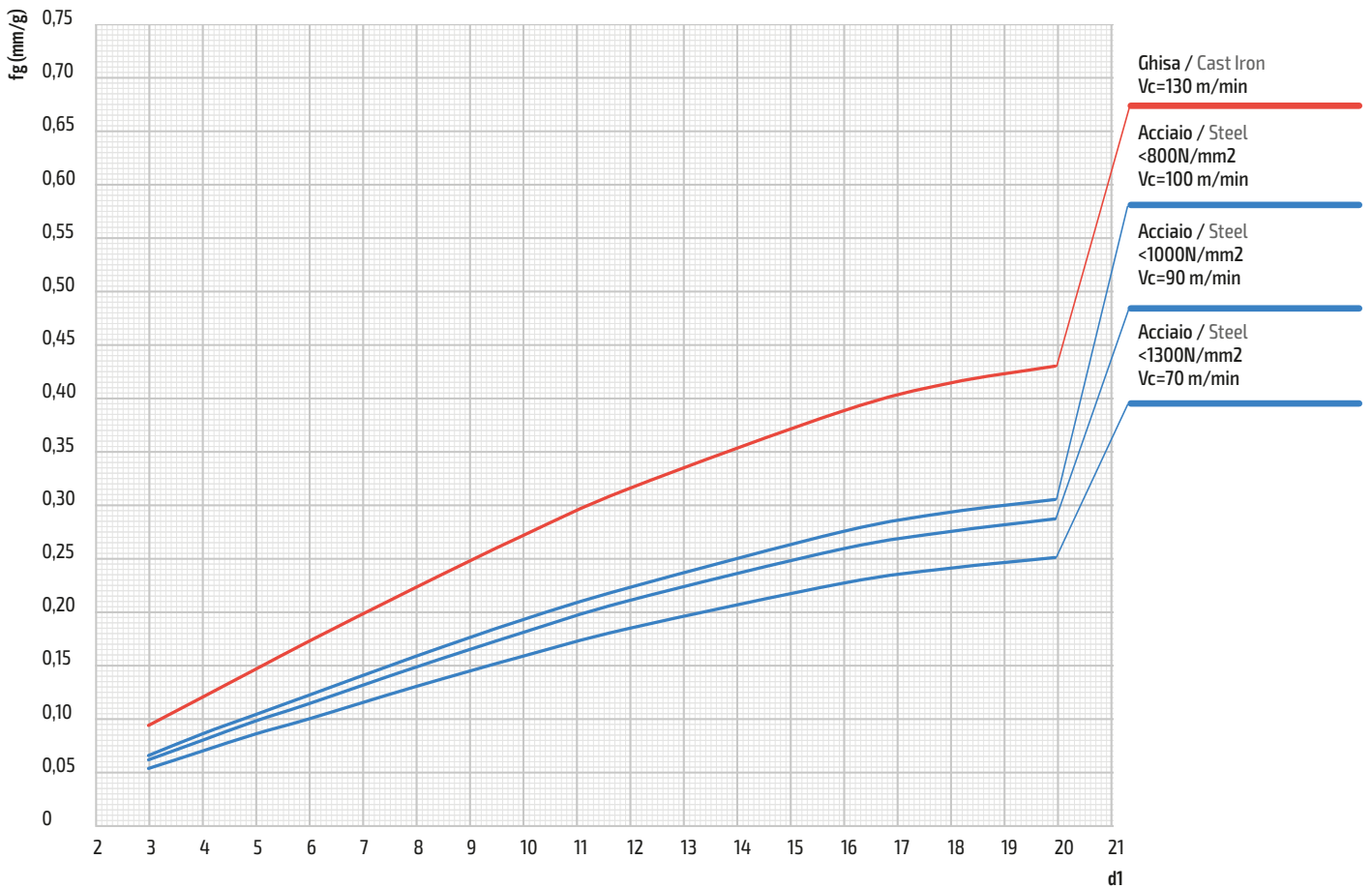

P

Acciaio
Steel
Stahl
Acier

H

Acciaio Temprato
Hardened Steel
Gehärteter Stahl
Acier trempé

K

Ghisa
Cast Iron
Gusseisen
Fonte

M

Acciaio Inox
Stainless Steel
Edelstahl
Acier Inoxydable

S

HRSA - Titanio
HRSA - Titanium
HRSA - Titan
HRSA - Titane

N

Metalli non ferrosi
Non-ferrous metals
NE-Metalle
Matières non ferreuses

O

NON ISO
Not ISO
Keine ISO
Pas d'ISO

3054A-3084A-3124A

Parametri di lavoro/Working Parameters/ Bearbeitungsparameter/Paramètres d'usinage

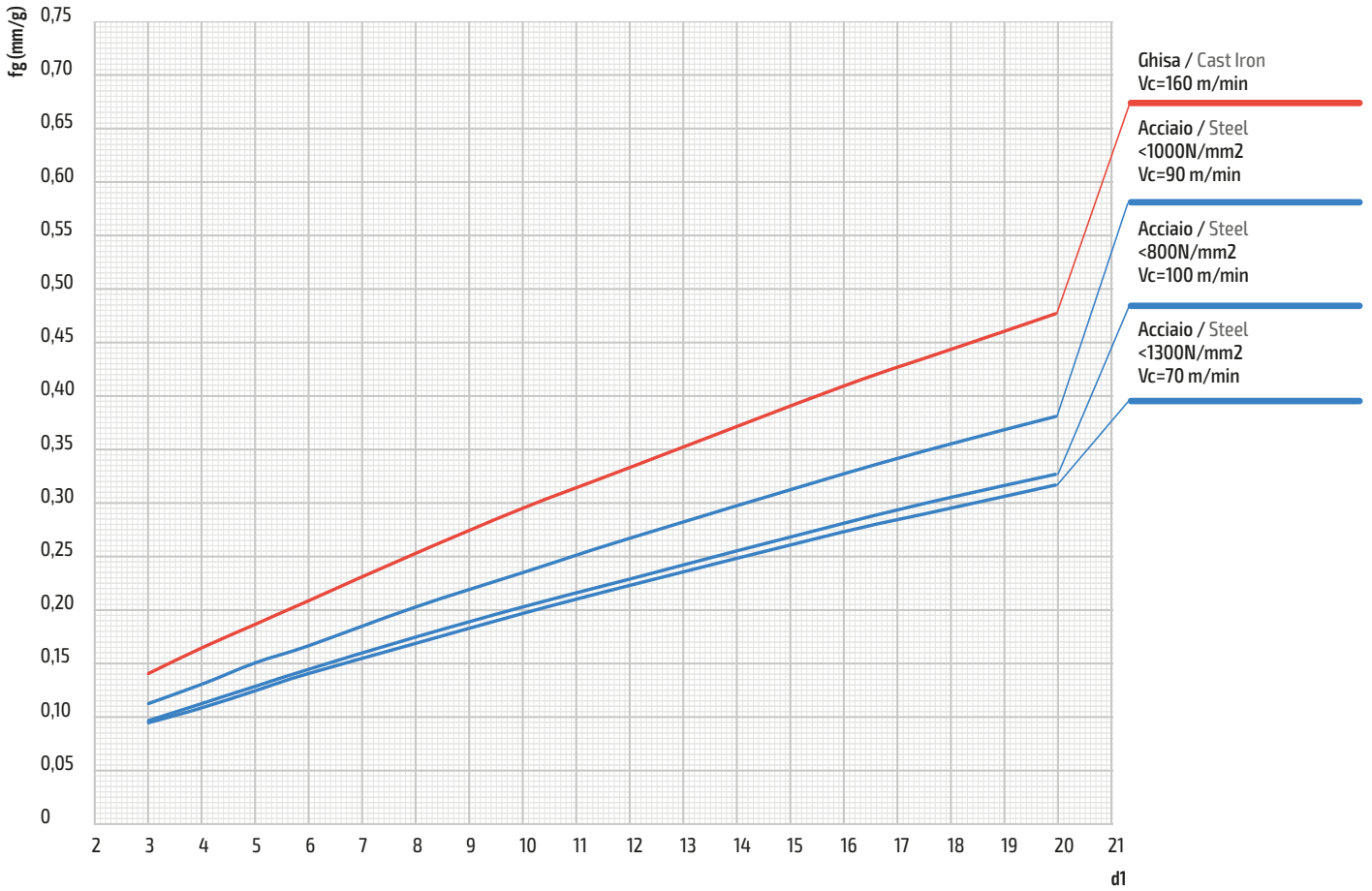

4031A-4051A

Parametri di lavoro/Working Parameters/
Bearbeitungsparameter/Paramètres d'usinage

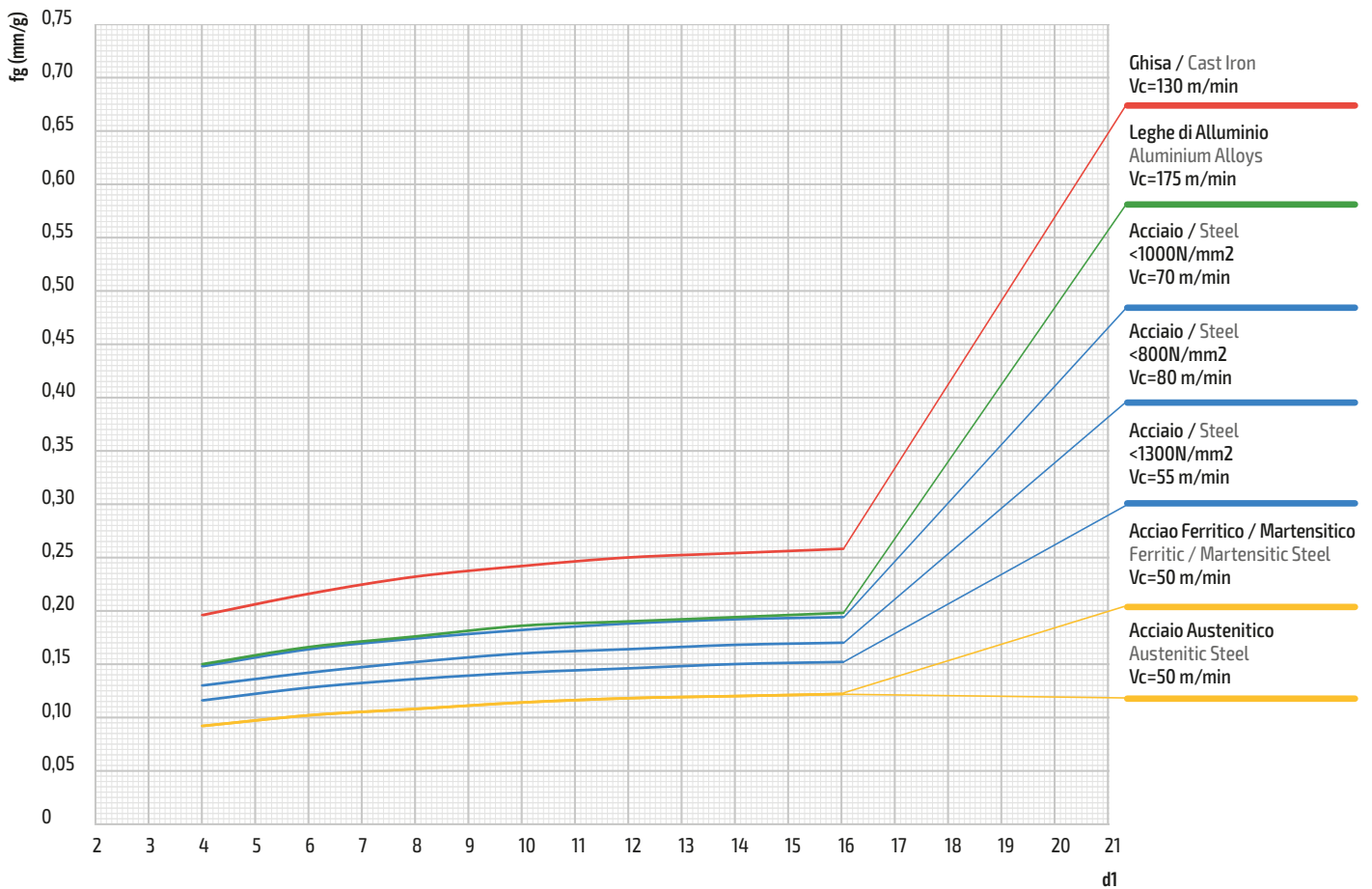

P

Acciaio
Steel
Stahl
Acier

H

Acciaio Temprato
Hardened Steel
Gehärteter Stahl
Acier trempé

K

Ghisa
Cast Iron
Gusseisen
Fonte

M

Acciaio Inox
Stainless Steel
Edelstahl
Acier Inoxydable

S

HRSA - Titanio
HRSA - Titanium
HRSA - Titan
HRSA - Titane

N

Metalli non ferrosi
Non-ferrous metals
NE-Metalle
Matières non ferreuses

O

NON ISO
Not ISO
Keine ISO
Pas d'ISO

3151A-3201A-3251A-3301A

Parametri di lavoro/Working Parameters/ Bearbeitungsparameter/Paramètres d'usinage

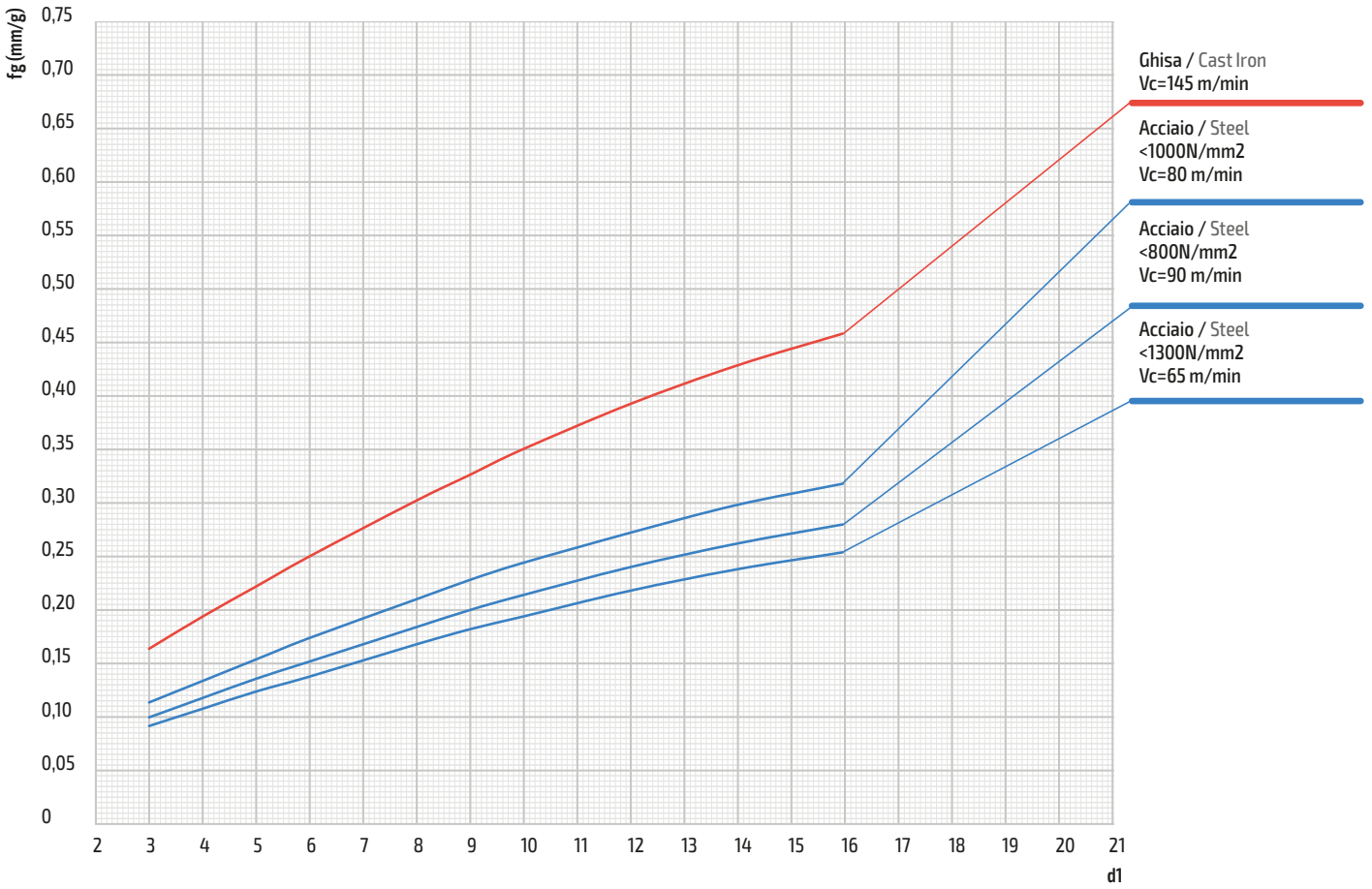

4038A-4058A

Parametri di lavoro/Working Parameters/
Bearbeitungsparameter/Paramètres d'usage

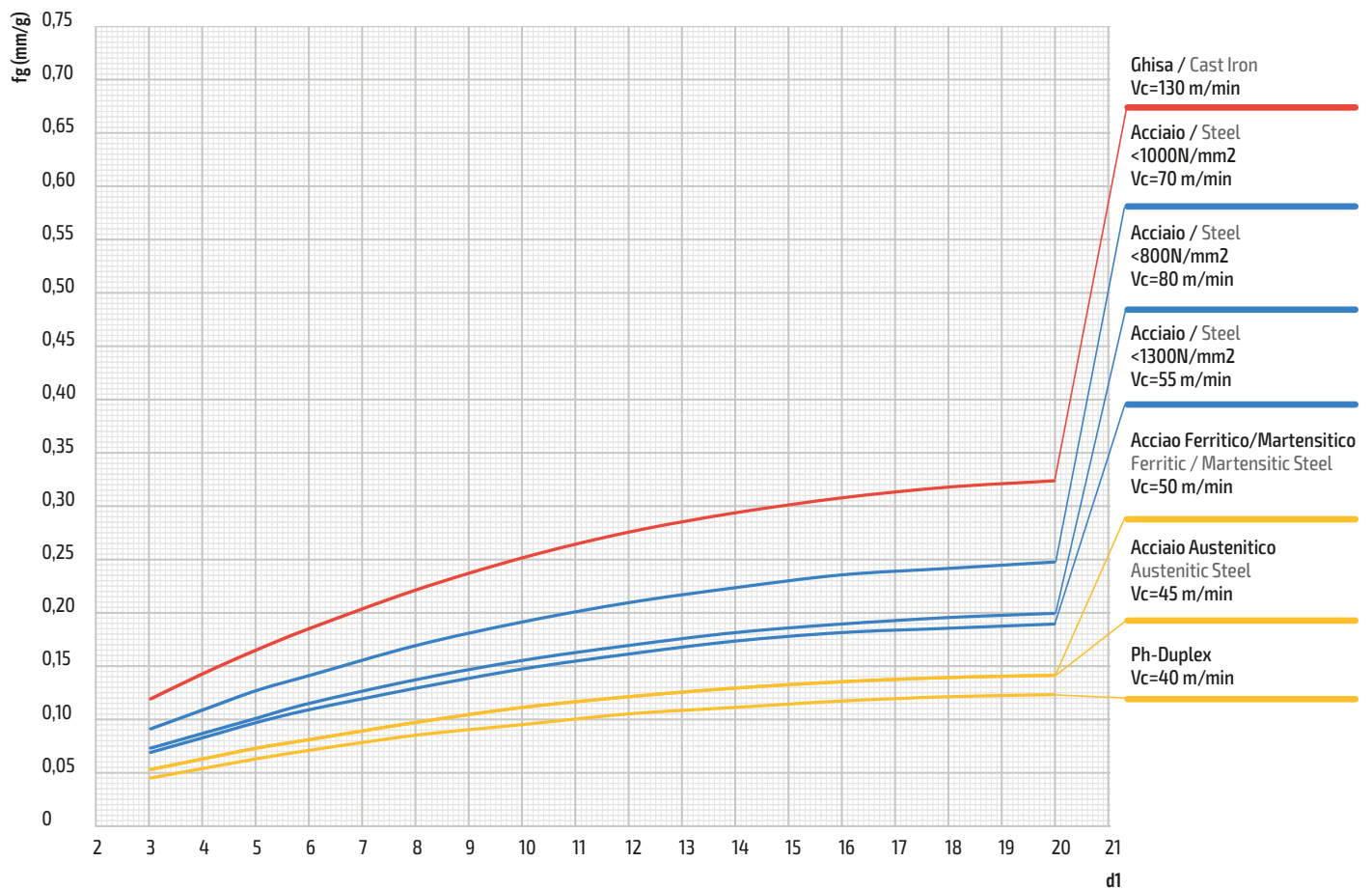

P

Acciaio
Steel
Stahl
Acier

H

Acciaio Temprato
Hardened Steel
Gehärteter Stahl
Acier trempé

K

Ghisa
Cast Iron
Gusseisen
Fonte

M

Acciaio Inox
Stainless Steel
Edelstahl
Acier Inoxydable

S

HRSA - Titanio
HRSA - Titanium
HRSA - Titan
HRSA - Titane

N

Metalli non ferrosi
Non-ferrous metals
NE-Metalle
Matières non ferreuses

O

NON ISO
Not ISO
Keine ISO
Pas d'ISO

3031S-3051S

Parametri di lavoro/Working Parameters/ Bearbeitungsparameter/Paramètres d'usage

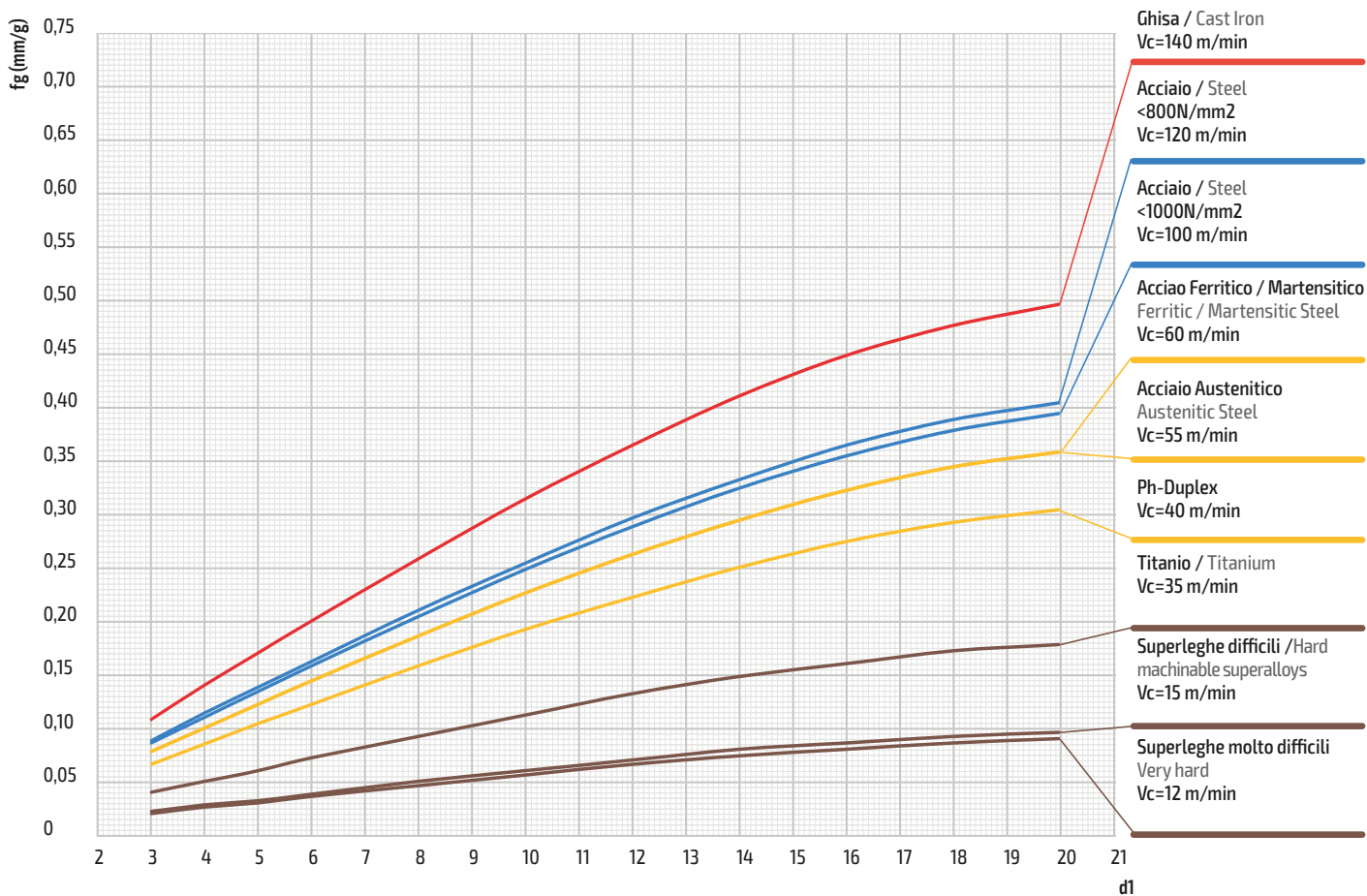

30815

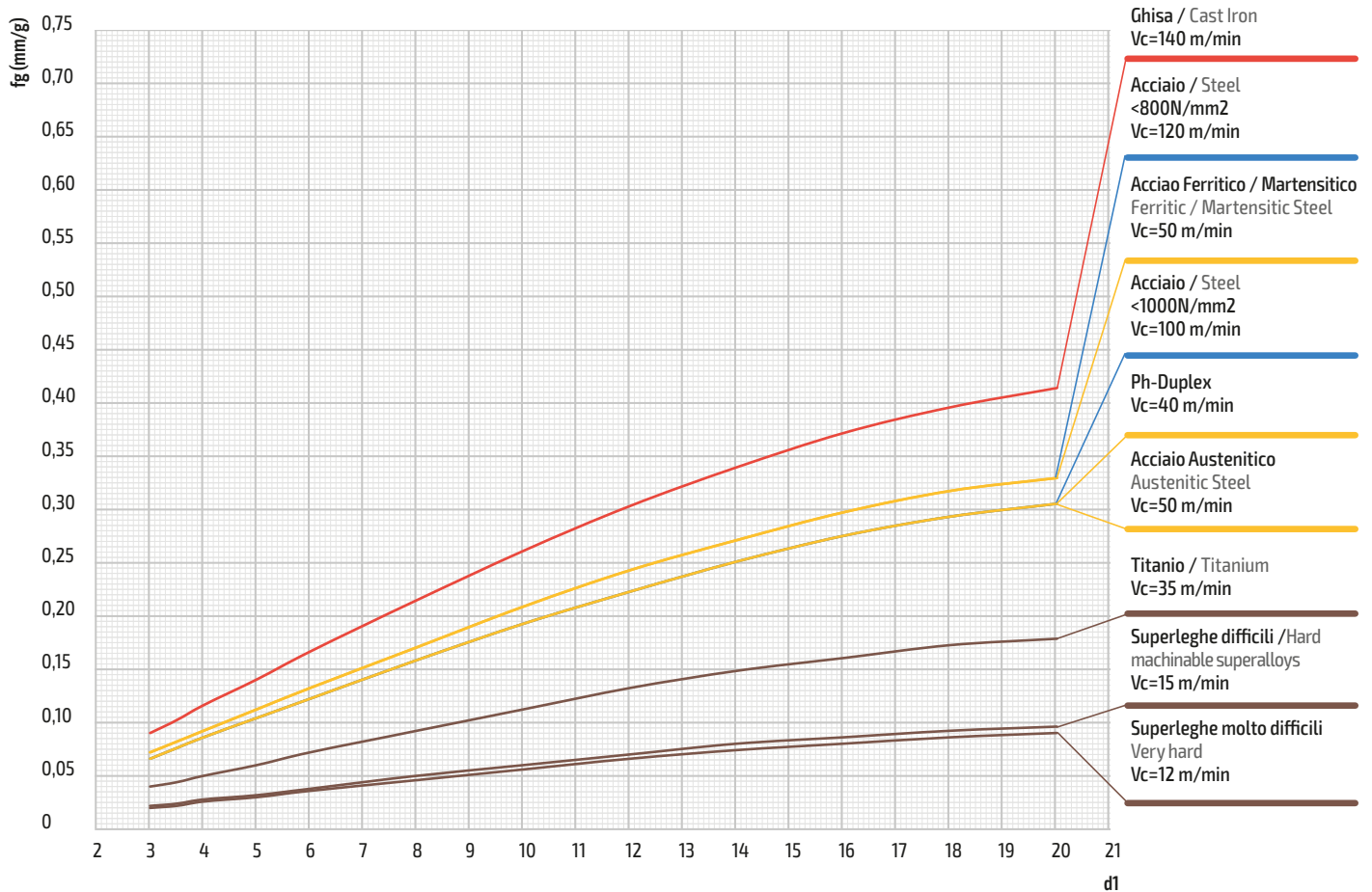
Parametri di lavoro / Working Parameters /
Bearbeitungsparameter / Paramètres d'usinage

P

Acciaio
Steel
Stahl
Acier

H

Acciaio Temprato
Hardened Steel
Gehärteter Stahl
Acier trempé

K

Ghisa
Cast Iron
Gusseisen
Fonte

M

Acciaio Inox
Stainless Steel
Edelstahl
Acier Inoxydable

S

HRSA - Titanio
HRSA - Titanium
HRSA - Titan
HRSA - Titane

N

Metalli non ferrosi
Non-ferrous metals
NE-Metalle
Matières non ferreuses

O

NON ISO
Not ISO
Keine ISO
Pas d'ISO

3051N

Parametri di lavoro/Working Parameters/ Bearbeitungsparameter/Paramètres d'usage

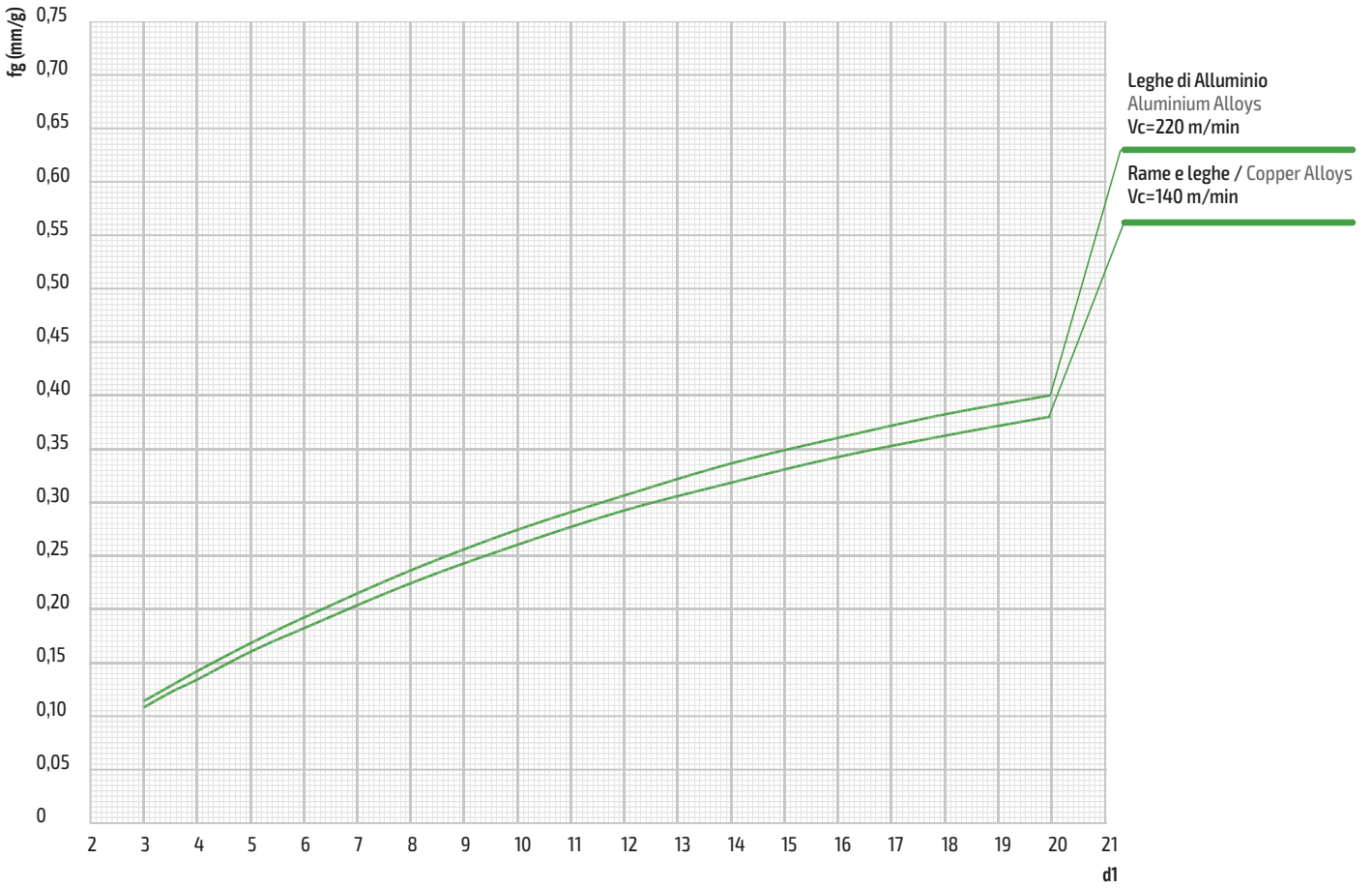

3151N-3201N-3251N

Parametri di lavoro/Working Parameters/
Bearbeitungsparameter/Paramètres d'usage

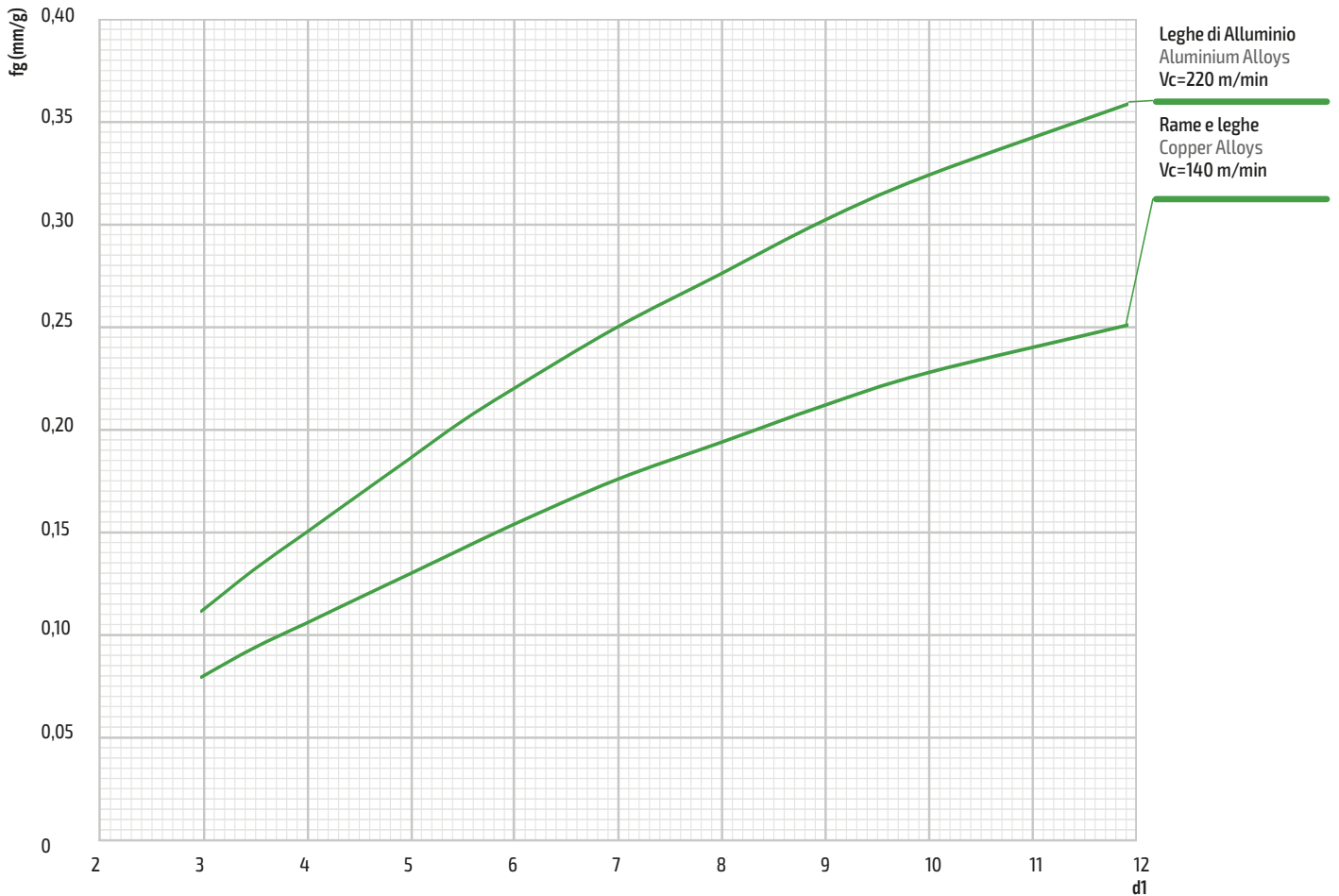

P

Acciaio
Steel
Stahl
Acier

H

Acciaio Temprato
Hardened Steel
Gehärteter Stahl
Acier trempé

K

Ghisa
Cast Iron
Gusseisen
Fonte

M

Acciaio Inox
Stainless Steel
Edelstahl
Acier Inoxydable

S

HRSA - Titanio
HRSA - Titanium
HRSA - Titan
HRSA - Titane

N

Metalli non ferrosi
Non-ferrous metals
NE-Metalle
Matières non ferreuses

O

NON ISO
Not ISO
Keine ISO
Pas d'ISO

3825-3835

Parametri di lavoro/Working Parameters/ Bearbeitungsparameter/Paramètres d'usinage

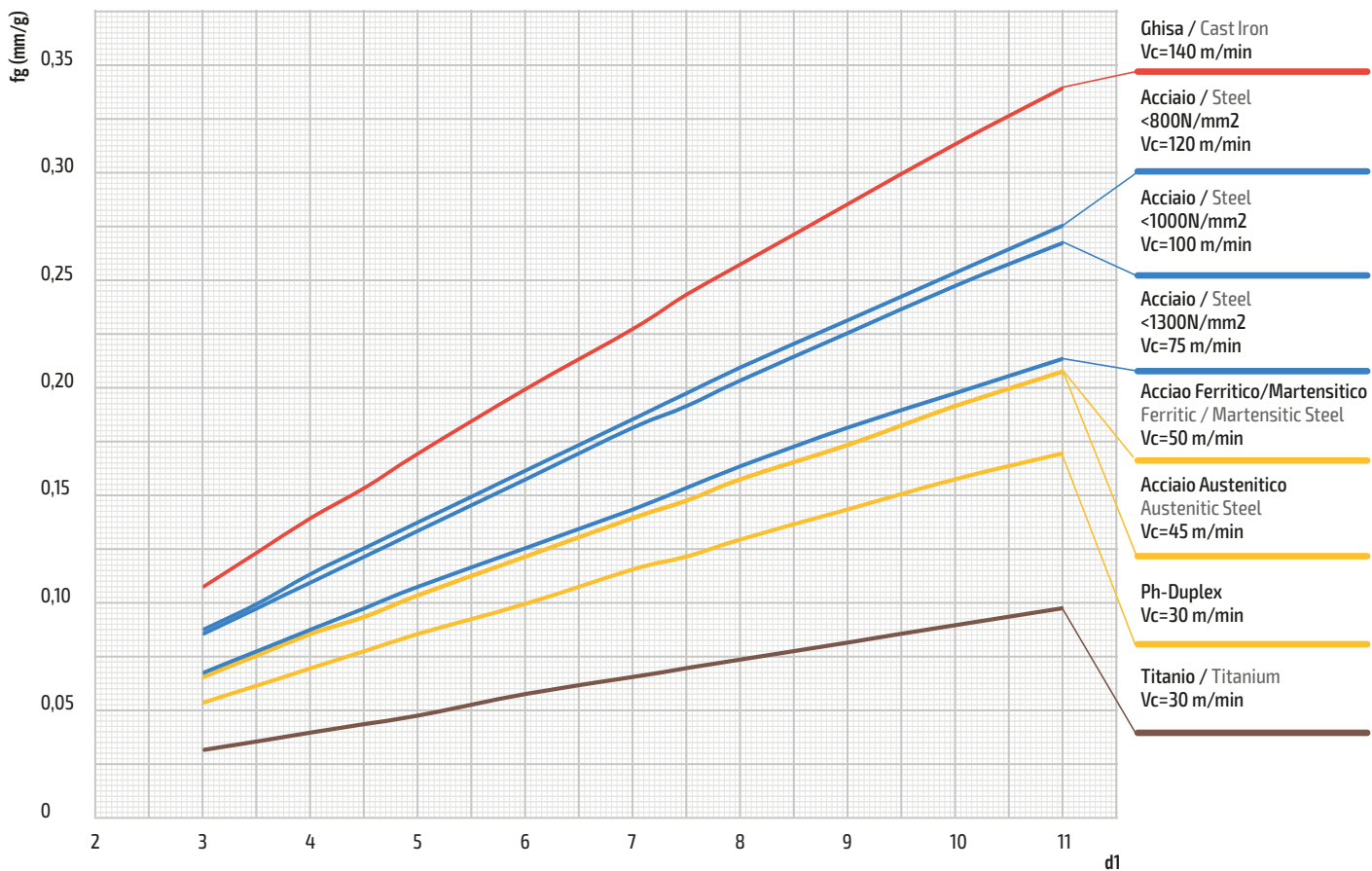

PROCEDURA DI FORATURA PROFONDA PER PUNTE 15-30xD

DEEP DRILLING PROCEDURE FOR 15-30xD DRILLS / TIEFBOHRPROZESS FÜR 15-30xD BOHRER / PROCEDURE DE PÉRÇAGE PROFOND POUR FORETS 15-30xD

FASE 1

Esecuzione preforo

Si consiglia l'utilizzo delle punte in metallo duro
Silmax art. 3031A.
Profondità preforo richiesta 2-3xD.

PHASE 1

Pre-drilling

We recommend the use of **Silmax carbide drills art. 3031A.**
Required pre-drilling depth 2-3xD.

PHASE 1

Vorbohren

Wir empfehlen die Verwendung von
Silmax-Hartmetallbohrern Art. 3031A
Erforderliche Bohrtiefe 2-3xD.

PREMIÈRE ÉTAPE

Avant trou avec foret pilote

Nous recommandons, au préalable, l'utilisation de **forets en carbure Silmax art. 3031A.**
Profondeur de perçage nécessaire 2-3xD.

FASE 2

Entrata nel preforo

Verificare runout punta, valore consigliato 0/+0,01 mm.
Entrare nel preforo con refrigerante spento a max
S200 giri/min e F500 mm/min.
Posizionarsi a +2 mm dalla fine del preforo.

PHASE 2

Entry into the pre-hole

Check drill runout, recommended value 0/+0,01 mm.
Enter the bore with coolant off at max. S200 rpm and
F500 mm/min.
Position +2 mm from the end of the pre-hole.

PHASE 2

Eintritt in das Vorloch

Bohrerlauf prüfen, empfohlener Wert 0/+0,01 mm.
Bohrung bei ausgeschaltetem Kühlmittel mit max.
S200 U/min und F500 mm/min durchführen.
In einem Abstand von +2 mm vom Ende des Vorloches
sich positionieren.

DEUXIÈME ÉTAPE

Entrée dans le trou pilote

Vérifier le faux-rond du foret, valeur recommandée
0/+0,01 mm.
Entrez dans le trou pilote sans liquide de refroidisse-
ment à une vitesse rotation maximale de S200 tr/min
et F500 mm/min.
Se positionner à +2 mm de l'extrémité de l'avant-trou.

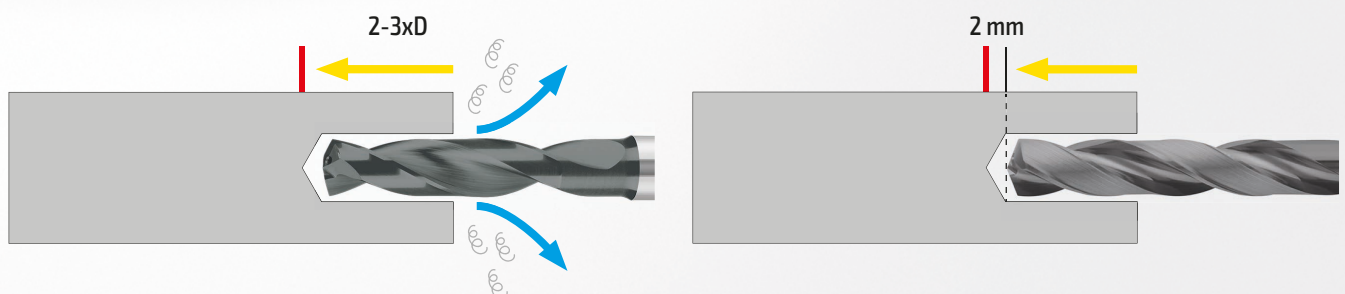

FASE 3

Ciclo di foratura

Accendere il refrigerante.
 Iniziare il ciclo di foratura con parametri di lavoro,
 S100% F100%.

PHASE 3

Drilling cycle

Switch on the coolant.
 Start drilling cycle with working parameters,
 S100% F100%.

PHASE 3

Bohrzyklus

Kühlmittel einschalten.
 Bohrzyklus mit Arbeitsparametern
 S100% F100% starten.

TROISIÈME ÉTAPE

Cycle de perçage profond

Activer l'arrosage.
 Commencer le perçage avec les paramètres de travail,
 S100% F100%.

FASE 4

Uscita dal foro

Al termine del ciclo arretrare al punto di partenza
 con S200 giri/min F5000 mm/min.
 Spegner refrigerante.
 Uscire dal foro a S200 giri/min e F500 mm/min.

PHASE 4

Exit from the hole

At the end of the cycle return to the starting point
 with S200 rpm F5000 mm/min.
 Switch off coolant.

PHASE 4

Austritt aus der Bohrung

Am Ende des Zyklus mit S200 U/min F5000 mm/min
 zum Startpunkt zurückkehren.
 Kühlmittel abschalten.

QUATRIÈME ÉTAPE

Sortie du trou

A la fin du cycle, revenir au point de départ avec
 S200 rpm F5000 mm/min.
 Arrêter l'alimentation en liquide de refroidissement.

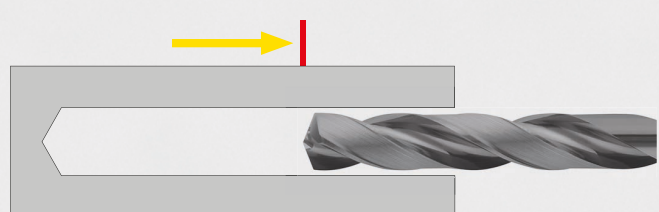
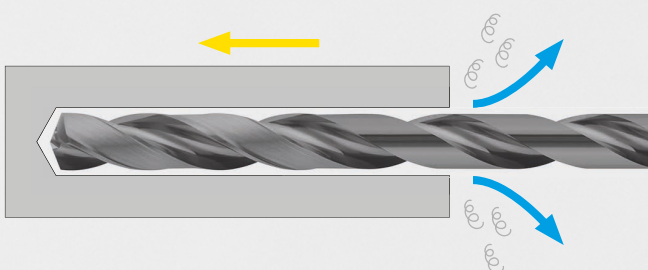

OPZIONI A RICHIESTA

OPTIONS UPON REQUEST

Attacco Weldon (Din) Weldon Shank (Din)

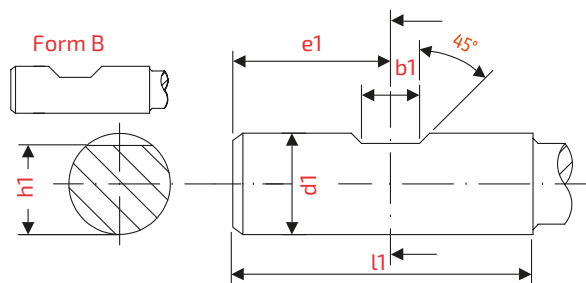

d1 h6	b1 +0,05/+0	e1	h1 11	l1
6,00	4,2	18,0	5,1	36
8,00	5,5	18,0	6,9	
10,00	7,0	20,0	8,5	40
12,00	8,0	22,5	10,4	45
14,00	8,0	22,5	12,7	
16,00	10,0	24,0	14,2	48
18,00	10,0	24,0	16,2	
20,00	11,0	25,0	18,2	50

Whistle notch

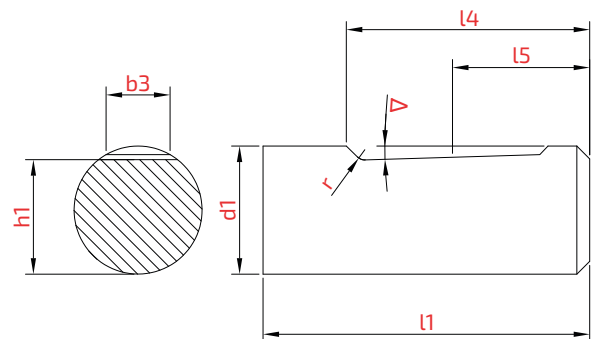

d1 h6	b3	h1	l1	l2	l3	r	Δ
6,00	4,3	5,1	36	25	18	1,2	2°
8,00	5,5	6,9		28	20		
10,00	7,1	8,5	40	20			
12,00	8,2	10,4	45	22,5			
14,00	8,1	12,7	48	33	24	1,6	
16,00	10,1	14,2		36	24		
18,00	10,8	16,2	48	24	24		
20,00	11,4	18,2	50	38	25		
25,00	13,6	23	56	44	32		
32,00	15,5	30	60	48	35		

Notes



Riaffilatura e rigenerazione: da usato a nuovo

Silmax è in grado di riaffilare e/o rigenerare come nuove frese, punte e alesatori, nelle versioni normali e speciali, utilizzando gli stessi impianti a 5 assi usati per la loro produzione.

Re-sharpening and re-conditioning: from used to new.

Silmax can re-sharpen and/or re-condition like new standard and special end mills, drills and reamers using the same 5-axis machines used for their production.

Nachschliff und Regeneration: von gebraucht bis neu

Silmax ist in der Lage, wie neue Fräser, Bohrer und Reibahlen in Standard- und Sonderversionen unter Verwendung derselben 5-Achsen-Produktionssysteme erneut zu schärfen und/oder zu regenerieren.

Réaffûtage et régénération

Réaffûtage et régénération de fraises, de forets et d'alesoirs standard et spéciaux en utilisant les mêmes installations à 5 axes utilisées pour leur fabrication.



Esecuzione perfetta

Esecuzione perfetta con la garanzia del produttore e collaudo effettuato su strumenti di controllo di alta precisione Zoller Genius e Walter Helicheck con emissione di certificato su richiesta.

Perfect execution

A perfect execution with the manufacturer's warranty and testing carried out with high-precision measurement instruments of Zoller Genius and Walter Helicheck, with issuing of certificate on request.

Perfekte Ausführung

Perfekte Ausführung mit der Garantie des Herstellers und Kontrolle mittels der Messmaschinen „Genius“ der Firma Zoller und „Helicheck“ der Firma Walter Maschinenbau mit Ausstellung des Zertifikates auf Anfrage.

Exécution parfaite

Exécution parfaite avec garantie du fabricant et essais sur des instruments de contrôle de haute précision Zoller Genius, Walter Helicheck et Alicona avec certificat délivré sur demande.



Rivestimento PVD

Rivestimento PVD eseguito nel nostro centro di rivestimento interno in Lanzo Torinese con la tecnologia Balzers sia per HSS che HM come Alcrona, Futura, Alnova, Latuma, TiN e Tisaflex.

PVD Coating

PVD coating in our in-house coating centre in Lanzo Torinese is carried out using Balzers technology, such as Alcrona, Futura, Alnova, Latuma, TiN and Tisaflex, both for HSS and HM tools.

PVD-Beschichtung

Durchgeführt in unserem internen Beschichtungszentrum in Lanzo Torinese, mit der Oerlikon Balzers Technologie sowohl für HSS als auch für HM wie Alcrona, Futura, Alnova, Latuma, TiN und Tisaflex

Revêtement PVD

Revêtement PVD effectué dans notre centre à Lanzo Torinese avec la technologie Balzers pour HSS et HM comme Alcrona, Futura, Alnova, Latuma, TiN et Tisaflex.



Trattamento 4S

Trattamento 4S di super finitura superficiale del filo tagliente pre e post rivestimento, eseguito con impianto OTEC e verificato con strumento di misura Alicona.

4S Treatment

4S super-finishing surface treatment of cutting edge before and after the coating process, is carried out using an OTEC system and checked with an Alicona measuring instrument.

4S-Behandlung

4S-Behandlung mit dem Superfinish Verfahren für die Feinbearbeitung der Schneidkantenoberfläche der Werkzeuge vor und nach der Beschichtung mittels Anlage der Firma OTEC Präzisionsfinish GmbH und mit Messinstrumenten der Firma Alicona überprüft.

Traitement 4S

Traitement 4S de super finition de la surface de l'arête coupe avant et après le revêtement, effectué avec l'équipement OTEC et vérifié avec l'instrument de mesure Alicona.



Consegna rapida

Consegna rapida entro 10 giorni lavorativi dal ricevimento degli utensili per riaffilatura e rivestimento.

Fast delivery

Fast delivery within 10 working days from receipt of tools for resharpener and coating.

Schnelle Lieferung

Schnelle Lieferung innerhalb von 10 Werktagen ab Empfang der Werkzeuge.

Livraison rapide

Livraison rapide dans les 10 jours ouvrables suivant la réception des outils.



